

Original Operating Manual



PowerMonitor PM+ HP15

LaserDiagnosticsSoftware LDS

IMPORTANT!

READ CAREFULLY BEFORE USE.

KEEP FOR FUTURE USE.

Table of contents

1	Basic safety notes	7
2	Icons and conventions	8
3	About this operating manual	10
4	Device description	10
4.1	Type overview	10
4.2	Functional description	11
4.3	Measuring principle	11
4.4	Tara/Fct. button	12
4.4.1	Tare function	12
4.4.2	Switching between the screens of the display	12
4.5	Optical displays	12
4.5.1	LEDs.....	12
4.5.2	Display	12
4.6	Explanation of the product safety labels and warning labels	14
4.7	Scope of delivery and optional accessories	15
5	Transport and storage	16
6	Mounting	17
6.1	Conditions at the installation site	17
6.2	Installation in the laser system	17
6.2.1	Prepare mounting	17
6.2.2	Possible mounting positions.....	18
6.2.3	Align the device	20
6.2.4	Mount the device	22
6.3	Removal from the laser system.....	23
7	Connectors	24
7.1	Overview of connectors.....	24
7.2	Power supply	25
7.2.1	Power supply via PRIMES power supply when used as a stand-alone device	26
7.2.2	Power supply via USB connection and communication with the PC via USB	27
7.2.3	Power supply via PRIMES power supply and communication with the PC via USB or Ethernet.....	28
7.2.4	Power supply via Power over Ethernet and communication with the PC via Ethernet	29
7.2.5	Power supply via USB-C power supply and communication with the PC via Ethernet	30
7.3	Power In	30
7.4	Ethernet/PoE In.....	31
7.5	USB	31
7.6	PRIMES Universal Connector (PUC).....	31
7.7	Safety interlock (Interlock).....	32
7.8	Cooling circuit (Water In/Water Out).....	34
7.8.1	Connect/remove cooling water hoses	34
7.8.2	Damage to the device.....	34
7.8.3	Avoid measurement inaccuracies.....	35
7.8.4	Damage to the flow meter.....	36
7.8.5	Parameters of cooling water connection	37
7.8.6	Pressure loss	38

8	Software installation	39
8.1	Install LaserDiagnosticsSoftware LDS.....	39
8.2	Connect PRIMES device to a PC	39
8.2.1	Integration of a PRIMES device into a network.....	39
8.2.2	Direct connection of a PRIMES device to a PC	39
9	Measuring	40
9.1	Warning messages.....	40
9.2	Preparing measurement readiness	41
9.3	Measuring with the PM+ as a stand-alone device.....	41
9.4	Measuring with the LaserDiagnosticsSoftware LDS.....	42
9.4.1	Connect/disconnect the device with the LDS.....	42
9.4.2	General information about working with the LDS.....	44
9.4.3	Open power measurement mode	46
9.4.4	Perform power measurement.....	46
9.4.5	Measurement results display	49
10	Troubleshooting	50
10.1	Messages in the LDS during measurement	50
10.2	Connection errors with the LDS.....	51
10.2.1	Ethernet connection errors.....	51
10.2.2	USB connection errors.....	51
10.3	Red flashing Status LED without an error message on the display.....	51
10.4	Warning or error message on the display.....	52
10.4.1	Warning message (Status LED lights up yellow)	52
10.4.2	Error message (Status LED flashes red)	53
10.5	Other errors.....	53
11	Maintenance and service	53
11.1	Maintenance intervals.....	53
11.2	Cleaning the device surface	53
11.3	Clean/replace sieve in the water filter.....	54
12	Measures for the product disposal	55
13	Declaration of conformity	56
14	Technical data	58
15	Dimensions	60
16	Appendix	62
A	Diagram of the max. laser power as a function of the beam diameter.....	62
B	GNU GPL license notice.....	62
C	Parallel operation of the PM+ HP15 with a FocusMonitor FM+	63
D	Parallel operation of the PM+ HP15 with a FocusTracker FT.....	65

PRIMES - the company

PRIMES is a manufacturer of measuring devices for the analysis of laser beams. These devices are used for the diagnostics of high-power lasers. This ranges from CO₂ lasers to solid-state and fiber lasers to diode lasers and the wavelength ranges from IR to near UV. A wide range of measuring devices is available to determine the following beam parameters:

- Laser power
- Beam dimensions and position of an unfocused beam
- Beam dimensions and position of a focused beam
- Beam quality factor M^2

Development, production and calibration of the measuring devices is performed at PRIMES. This guarantees optimum quality, excellent service, and a short reaction time, providing the basis for us to meet all of our customers' requirements quickly and reliably.



PRIMES GmbH
Max-Planck-Str. 2
64319 Pfungstadt
Germany

Tel +49 6157 9878-0
info@primes.de
www.primes.de

1 Basic safety notes

Intended use

The device has been designed exclusively for measurements in the beam of high-power lasers.

Use for any other purpose is considered as not intended and is strictly prohibited. Furthermore, intended use requires that all information, instructions, safety notes and warning messages in this operating manual are observed. The specifications given in chapter 14 „Technical data“ on page 58 apply. Any given limit values must be complied with.

If not used as intended, the device or the system in which the device is installed can be damaged or destroyed. In addition, there is an increased risk to health and life. Only use the device in such a way that there is no risk of injury.

This operating manual is an integral part of the device and must be kept in the immediate vicinity of the place of use, accessible to personnel at all times.

Every person who is responsible for the installation, start-up or operation of the device must have read and understood the operating manual and, in particular, the safety instructions.

If you still have questions after reading this operating manual, please contact PRIMES or your supplier for your own safety.

Observing applicable safety regulations

Observe the safety-relevant laws, guidelines, standards and regulations in the current editions published by the state, standardization organizations, professional associations, etc. In particular, observe the regulations on laser safety and comply with their requirements.

Necessary safety measures

The device measures direct laser radiation, but does not emit any radiation itself. However, during the measurement the laser beam is directed at the device. This produces scattered or directed reflection of the laser beam (laser class 4). The reflected beam is usually not visible.

Protect yourself from direct and reflected laser radiation while working with the device by taking the following measures:

- Never leave the device unattended when taking measurements.
- Wear **safety goggles** adapted to the power, power density, laser wavelength and operating mode of the laser beam source in use.
- Wear suitable **protective clothing** or **protective gloves** if necessary.
- If possible, also protect yourself from direct laser radiation and scattered radiation by using separating protective devices that block or attenuate the radiation.
- If the device is moved from its aligned position, increased scattered or directed reflection of the laser beam occurs during measuring operation. Mount the device in such a way that it cannot be moved unintentionally, i.e. by bumping or pulling the cables
- Connect the laser control's safety interlock to the device. Check that the safety interlock will switch off the laser properly in case of error.
- Install safety switches or emergency safety mechanisms that allow the laser to be switched off immediately.
- Use suitable beam guidance and beam absorber elements which do not emit any hazardous substances when irradiated.

Employing qualified personnel

The device may only be operated by qualified personnel. The qualified personnel must have been instructed in the installation and operation of the device and must have a basic understanding of working with high-power lasers, beam guiding systems and focusing units.

Conversions and modifications

The device may not be modified in terms of design or safety without the explicit consent of the manufacturer. The same applies to unauthorized opening, dismantling and repair. The removal of covers is only permitted within the scope of the intended use.

Liability disclaimer

Manufacturer and distributor exclude any liability for damages and injuries which are direct or indirect consequences of using the device not as intended or modifying the device or the associated software without authorization.

2 Icons and conventions

Warning messages

The following icons and signal words indicate possible residual risks in the form of warnings:



DANGER

Means that death or serious physical injuries **will** occur if necessary safety precautions are not taken.



WARNING

Means that death or serious physical injuries **may** occur if necessary safety precautions are not taken.



CAUTION

Means that minor physical injury **may** occur if necessary safety precautions are not taken.

NOTICE

Means that property damage **may** occur if necessary safety precautions are not taken.

Product safety labels

The following icons are used on the device itself to indicate imperatives and possible dangers:



Read and understand the operating manual before using the device!



Do not reach inside!



Labeling according to WEEE directive:

The device must not be disposed of with household waste, but in a separate WEEE collection in an environmentally friendly way.

Further icons and conventions in this operating manual



Here you will find useful information and helpful tips.

- ▶ Indicates a single instruction.
If several of these instructions appear one below the other, the order in which they are executed is irrelevant or they represent alternative courses of action.
- 1. A numbered list identifies a sequence of instructions that must be executed in the specified order.
- 2.
- ...
- ➔ Indicates the result of an action to explain processes that take place in the background.
- 👁 Indicates an observation prompt to draw attention to visible feedback from the device or the software.
Observation prompts make it easier to check whether an instruction was executed successfully. Often they also guide to the next instruction.
- 👆 Points to a control element that is to be pressed/clicked.
- ← Points to an element described in the text (for example an input field).

3 About this operating manual

This manual describes the installation and operation of the PowerMonitor PM+ HP15 and how to perform measurements:

- as a stand-alone-device
- with the LaserDiagnosticsSoftware LDS version 4.0 or higher.

In this operating manual, the abbreviations PM+ and LDS are used below.

For measurement operation with a PC, the LDS must be installed on the PC. The LDS is included in the scope of delivery. PRIMES will also be happy to provide you with a current download link.

For this purpose, contact your sales partner or send an e-mail to: **support@primes.de**

The software description includes a brief introduction on using the device for measurements. For a detailed description of the software installation, file management and evaluation of the measurement data, please refer to the separate instructions for the LDS.



This operating manual describes the software version valid at the time of printing. Since the LDS is subject to continuous development, the supplied data medium may have a newer version number.

4 Device description

4.1 Type overview

The PM+ can be equipped with different flow meters:

- Turbine
- Oval wheel meter

The configuration of the device can be found on the identification plate:

PM+ with Turbine	PM+ with Oval wheel meter
Marking A	Marking B

Fig. 4.1: Marking of PM+ configuration with turbine or oval wheel meter

4.2 Functional description

The PM+ is a measuring device for determining the power of laser beams in the multi-kilowatt range with wavelengths in the CO₂, NIR and VIS range.

The main application is to monitor the laser power available in the processing area of CO₂, solid-state lasers or high-power diode lasers.

The device is suitable for measuring collimated laser beams as well as divergent and convergent laser beams.



Fig. 4.2: Functional description

4.3 Measuring principle

The PM+ offers a fast power measurement using the calorimetric measuring principle with active cooling.

The laser beam hits a deflection mirror in the device. This deflects the beam through an aperture and expands it so that it irradiates as much absorber surface as possible.

The total irradiated laser power is absorbed by a water-cooled absorber in the device. The absorbed power is determined by measuring the cooling water flow rate and the temperature difference between water supply and water return.

Based on the temperature rise and thermal properties of the absorber, the microprocessor-based electronics are able to calculate the laser power with a high degree of accuracy.

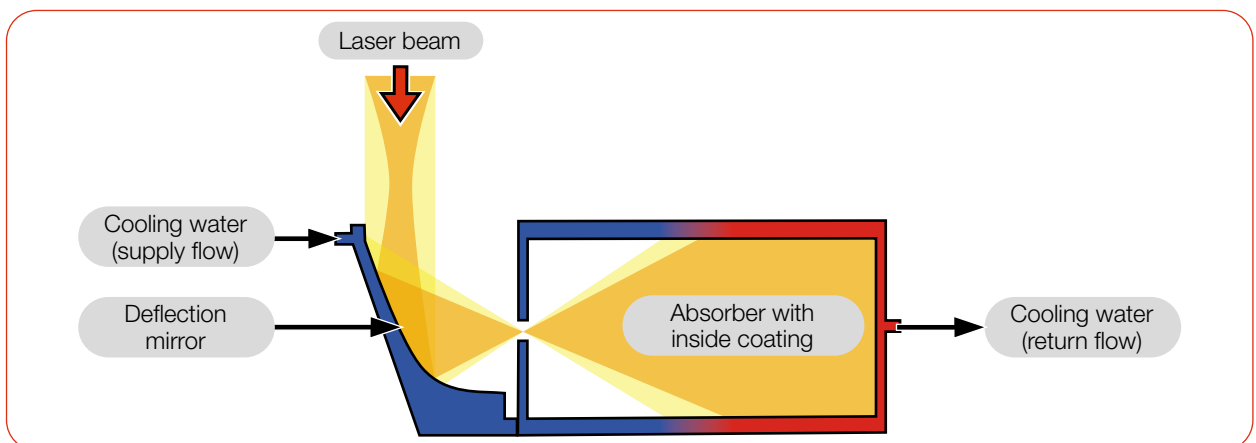

Fig. 4.3: Measuring principle (schematic)

4.4 Tara/Fct. button

The Tara/Fct. button has two functions:

- Tare function
- Switching between the screens of the display

4.4.1 Tare function

Pressing and holding the Tara/Fct. button (> 0.5 s) applies the currently measured power value as an offset. The tare screen (without illustration) is displayed for confirmation.

4.4.2 Switching between the screens of the display

Different information can be shown on the display.

By briefly pressing the Tara/Fct. button, you can cycle through the different screens.

4.5 Optical displays

4.5.1 LEDs

The LEDs indicate different states of the PM+.

LED	Color	Meaning
Status	Green	Measurement running without errors.
	Yellow	Warning message (see chapter 10.4.1 on page 52).
	Flashes red	Error message. The safety interlock has been triggered (see chapter 10.4.2 on page 53).
Power	White	Power supply is switched on.

Tab. 4.1: Meaning of the LEDs

4.5.2 Display

Six different screens can be shown on the display:

- Start
- Measurement
- Warning
- Status
- Service
- Tare (without illustration)

When the device is powered on, the Start screen is displayed for approx. 1 second.

Then the Measurement screen appears.

Briefly pressing the Tara/Fct. button scrolls to the next screen. Four screens can be cycled: Measurement, Warning, Status and Service.

The following information is displayed on the respective screen:

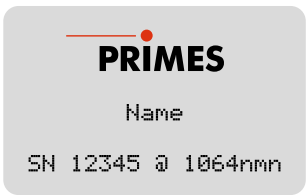
Start	
<ul style="list-style-type: none"> the short name of the device the user-defined device name (this can be entered via the LDS) the serial number and set calibrated wavelength 	

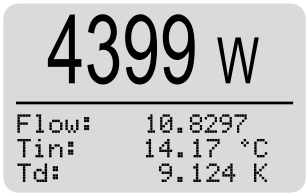
Measurement	
<ul style="list-style-type: none"> the currently measured laser power in Watt the flow rate of the cooling water in l/min (Flow) the cooling water temperature T_{in} at the water supply (Water In) in °C the temperature difference T_d between water supply (Water In) and water return (Water Out) in Kelvin 	

The PM+ monitors a wide variety of parameters. In case of deviating parameters, a warning triangle is shown on the display. At the same time, the Status LED lights up yellow or flashes red. For an explanation of the messages, please refer to chapter 10.4 „Warning or error message on the display“ on page 52.

The Warning screen displays a symbol for the error messages listed below. Usually, a warning is associated with an increased uncertainty of measurement.

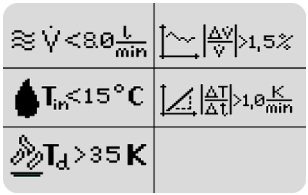
Warning	
<ul style="list-style-type: none"> the cooling water flow is too low ($V < 8.0$ l/min) the fluctuations of the flow rate of the cooling water are too high ($> 1,5$ %) the cooling water temperature at the water supply (Water In) is too low/high ($T_{in} < 15$ °C / > 30 °C) the temperature fluctuations at the water supply (Water In) are too high ($> 1,0$ K/min) the temperature difference between the water supply (Water In) and the water return (Water Out) is too high ($T_d > 35$ K) 	
Without error “no warning” is displayed.	

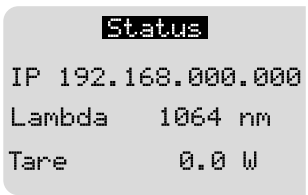
Status	
<ul style="list-style-type: none"> IP-address or „USB“ when using USB operation the set calibrated wavelength The current tara value (this is 0 after switching on the device; it remains so until you have tared using the Tara/Fct. button or set a value in the LDS) 	

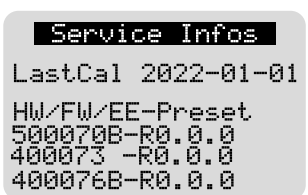
Service	
<ul style="list-style-type: none"> the date of the last calibration the hardware version the firmware-version the preset-version 	

4.6 Explanation of the product safety labels and warning labels

Potential hazard areas are marked on the device with the product safety label “Do not reach inside” and a warning label:

Product safety label “Do not reach inside”

Do not reach into the entrance aperture. Touching the deflection mirror underneath the shutter can lead to localized absorption of the laser radiation at the points of contact, leading to burn marks and increased scattered radiation.

Warning label “Do not use compressed air”

The flow meter is damaged by the use of compressed air in the cooling circuit. Do not use compressed air for emptying the cooling circuit.

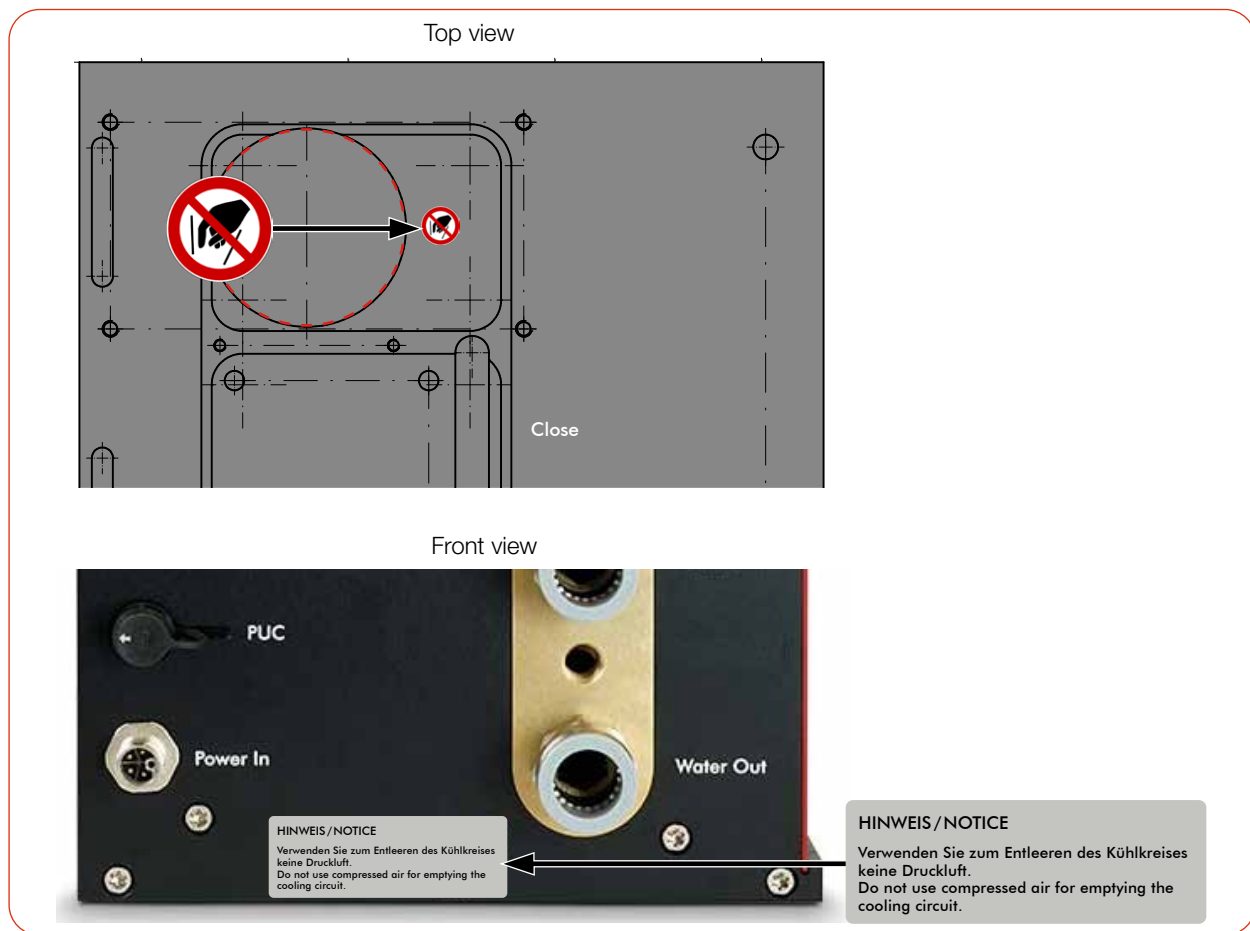

Fig. 4.4: Product safety label “Do not reach inside” and warning label

4.7 Scope of delivery and optional accessories

The scope of delivery includes:

- PowerMonitor PM+ HP15
- PRIMES USB flash drive
- Operating manual
- PRIMES power supply (24 V)
- USB cable (C to A connector), 2 m
- USB to Ethernet adapter
- Ethernet cable, 5 m
- Safety interlock cable
- 2 sealing plugs for cooling circuit (installed)

The following accessories are optional:

- Transport and storage case
- Adapter plate for FocusMonitor FM+
(see Appendix C on page 63)
- Adapter plate for FocusTracker FT
(see Appendix D on page 65)

5 Transport and storage

NOTICE

Damage/Destruction of the device

Hard hits or falls may damage the device.

Touching the deflection mirror underneath the shutter can lead to localized absorption of the laser radiation at the points of contact, leading to burn marks and increased scattered radiation.

- ▶ Do not reach into the entrance aperture.
- ▶ Handle the device carefully when transporting it.

NOTICE

Damage/Destruction of the device caused by leaking or freezing cooling water

Leaking cooling water can damage the device. Transporting and storing the device at temperatures near or below freezing and without emptying the cooling circuit completely can damage the device.

- ▶ Empty the lines of the cooling circuit completely.
- ▶ Even when the lines of the cooling circuit have been emptied, a small amount of residual water will remain in the device at all times. This may leak out and end up inside the device. Close the connectors of the cooling circuit with the included sealing plugs.

NOTICE

Damage/Destruction of the flow meter

The flow meter is damaged by the use of compressed air in the cooling circuit.

- ▶ Do not use compressed air for emptying the cooling circuit.

6 Mounting

6.1 Conditions at the installation site

- The device must not be operated in a condensing atmosphere.
- The ambient air must be free of gases and aerosols that interfere with the laser radiation (e.g. organic solvents, cigarette smoke, sulfur hexafluoride).
- Protect the device from spray water and dust.
- Operate the device in closed rooms only.

6.2 Installation in the laser system

6.2.1 Prepare mounting

1. Switch off the laser beam.
2. Ensure that moving parts, e.g. robot arms, etc. are at a standstill and that they cannot be set in motion unintentionally.
3. Check the space available before installing the device, especially the required space for the connection cables and - hoses.

6.2.2 Possible mounting positions

Device with turbine

The PM+ can be mounted in any installation position.

Device with oval wheel meter

The PM+ can be mounted in the installation positions shown in Fig. 6.1 on page 19:

- Text on connector side the right way up, beam incidence from above
- Text on connector side upside down, beam incidence from below
- Connector side up, device vertical
- Connector side down, device vertical

The device must not be installed lying on its side.



For a short period of time (a few hours per year) the PM+ with oval wheel meter can be operated in the “incorrect” installation position without immediately causing damages to the device. Longer operation periods, however, may cause accelerated wear.

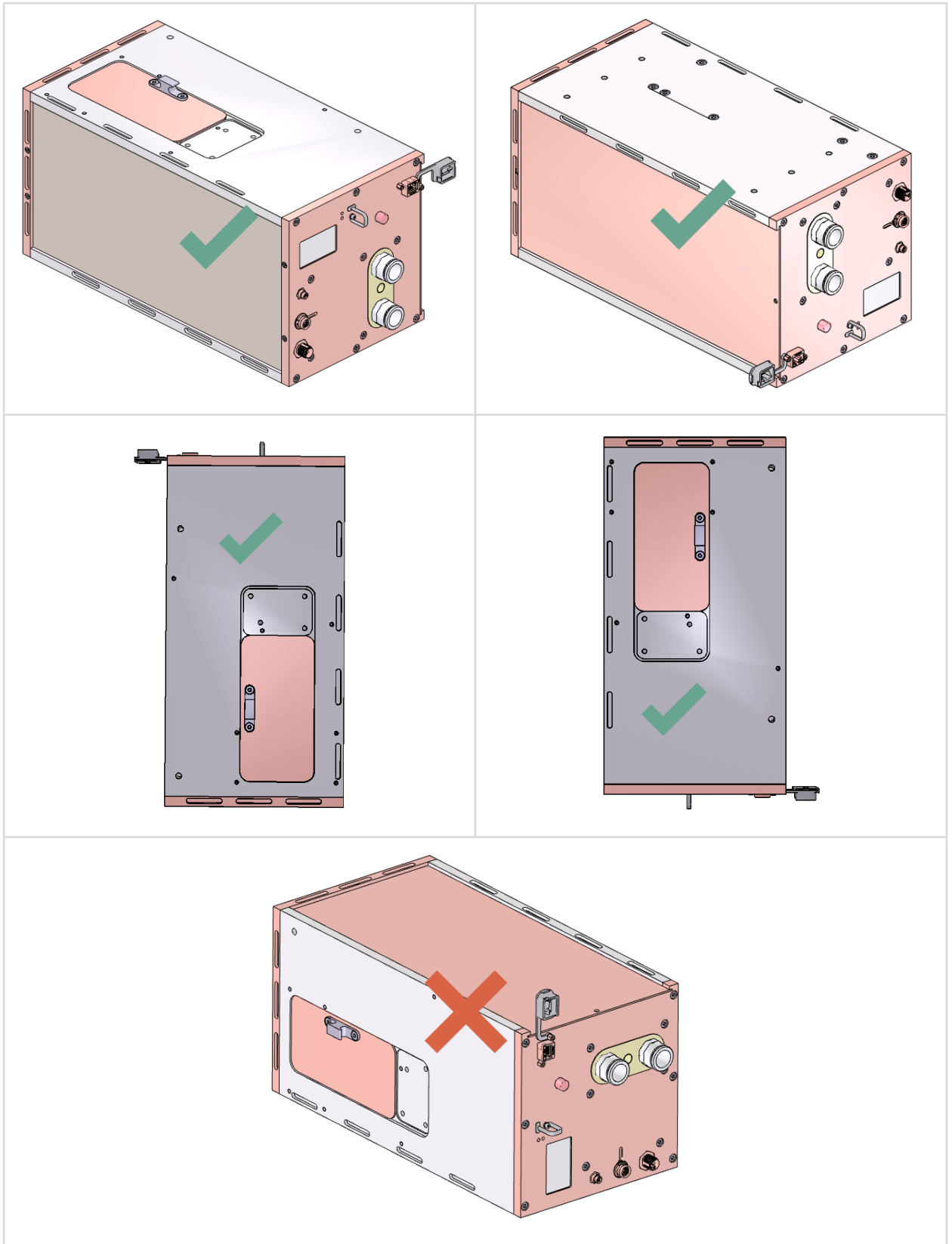

Fig. 6.1: Installation positions for a device with oval wheel meter

6.2.3 Align the device

NOTICE

Damage/Destruction of the device

The deflection mirror can be damaged if the power density is too high.

- ▶ Make sure the focal plane is not located on the deflection mirror.
- ▶ Make sure that the permitted power density on the deflecting mirror is not exceeded.

The device must be aligned to the laser beam. The laser beam must hit the entrance aperture centrally and perpendicular. The specifications given in chapter 14 „Technical data“ on page 58 must be observed.

The reticle printed on the shutter can be used to center the device under the laser. Align the device using the pilot beam with the shutter closed.

Use of the device with divergent laser radiation

Normally, the device is positioned underneath the focal plane of the beam path for power measurement.

Use of the device with convergent laser radiation

If this is not possible, the device can be positioned above the focal plane.

In this case, observe that the laser radiation is convergent and that the permitted power density on the deflection mirror is not exceeded.

Observe the following (see chapter 14 „Technical data“ on page 58):

- the max. laser power as a function of the beam diameter according to appendix A on page 62
- the maximum beam diameter of 24 mm at the entrance aperture
- the max. tolerance to the centered beam incidence of ± 3 mm
- the min. divergence full angle of $- 50$ mrad (convergent) /
the max. divergence full angle of $+ 160$ mrad (divergent)
- the max. angle of incidence perpendicular to the entrance aperture of $\pm 5^\circ$

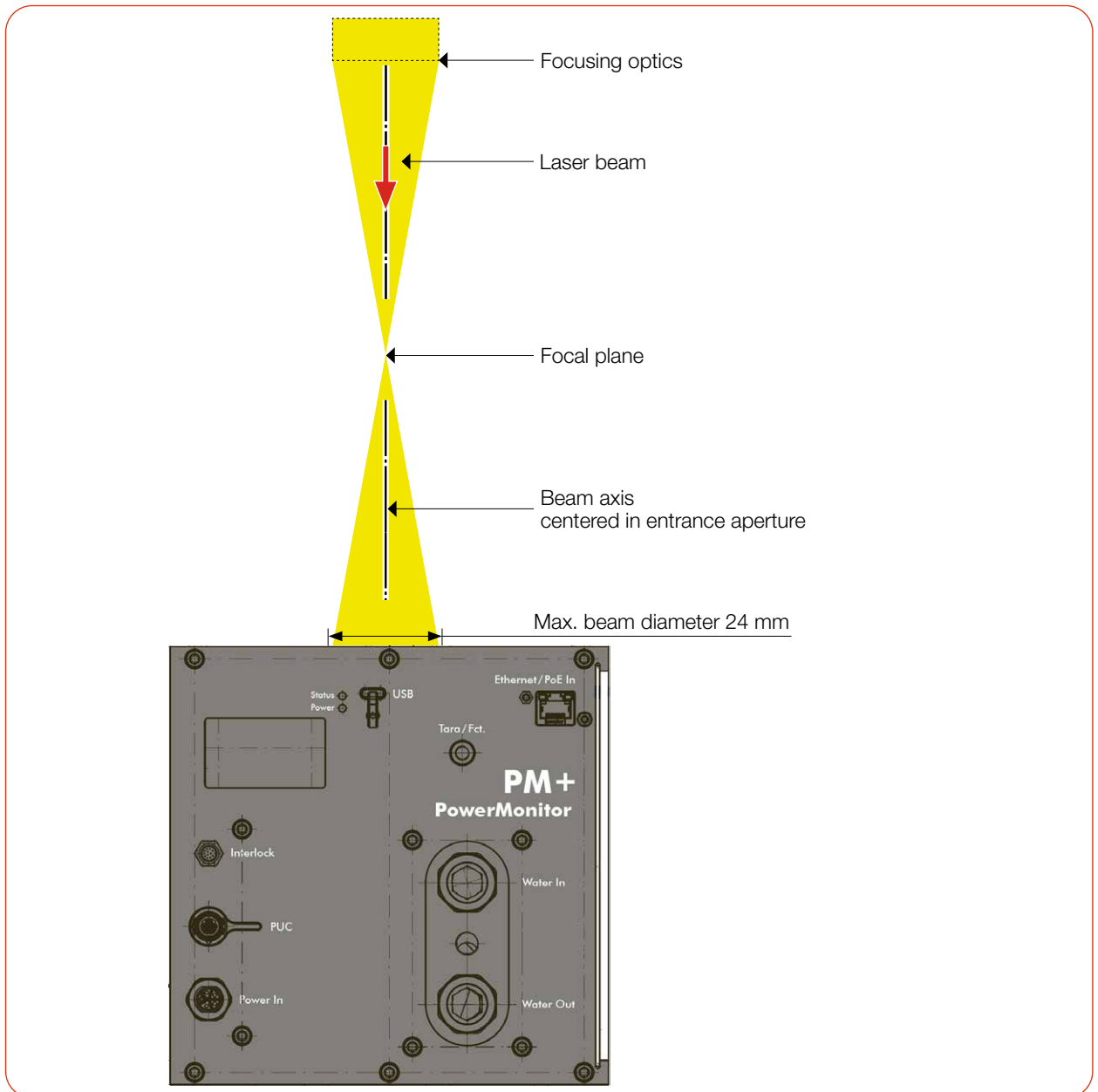

Fig. 6.2: Alignment of the PM+ to the laser beam (schematic)

6.2.4 Mount the device

DANGER

Serious injuries if the device falls down

If the device is not fastened securely, it may fall down.

- ▶ The secure fastening of the device according to the selected mounting position and the selection of the screws with appropriate tightening torque or with claws must be carried out by the customer.

DANGER

Serious eye or skin injury due to laser radiation

If the device is moved from its aligned position, increased scattered or directed reflection of the laser beam occurs during measuring operation (laser class 4).

- ▶ Mount the device so that it cannot be moved by an unintended push or a pull on the cables or hoses.

NOTICE

Damage/Destruction of the device

Fastening screws which are too long can damage internal components in the device.

- ▶ Do not use screws that protrude more than 8 mm into the housing.

The device offers 2 different options for mounting:

Mounting with screws

The housing has M6 threaded holes (red arrows) for mounting the device on a customer specific mount.

- ▶ If necessary, remove the device feet. Mount the device in the threaded holes. The fastening screws must not protrude into the housing by more than 8 mm.

Mounting with claws

The housing has recesses (blue arrows) for mounting the device on a customer specific mount.

- ▶ If necessary, remove the device feet. Mount the device in the recesses.

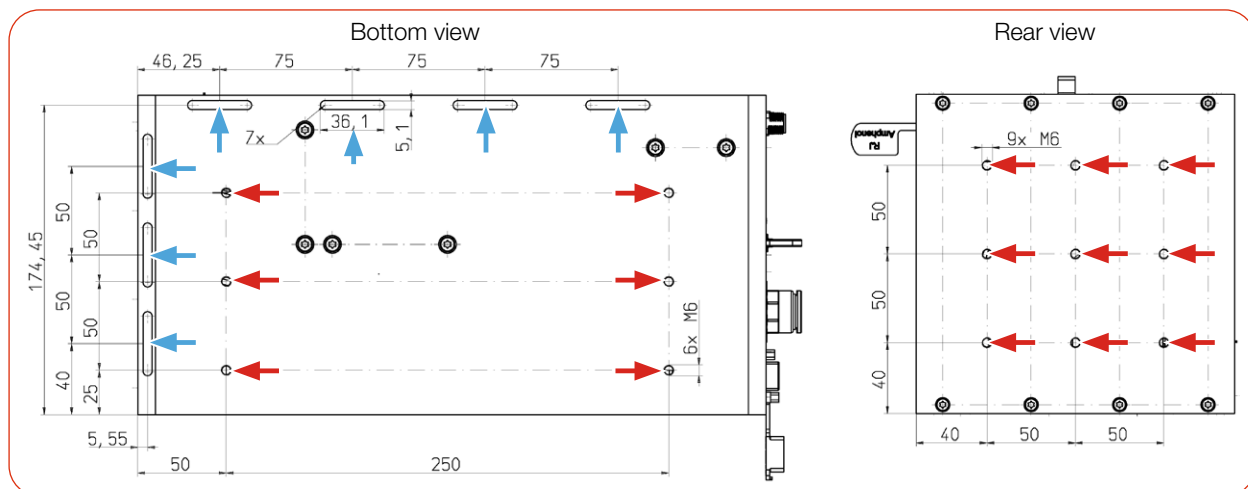

Fig. 6.3: Mounting options (dimensions in mm)

6.3 Removal from the laser system



CAUTION

Eye and skin damage

If the cooling water hoses are disconnected while the water supply is on, high-pressure water may be sprayed into the eyes.

- ▶ Turn off the water supply before disconnecting the cooling water hoses.

NOTICE

Damage/Destruction of the flow meter

The flow meter is damaged by the use of compressed air in the cooling circuit.

- ▶ Do not use compressed air for emptying the cooling circuit.

1. Switch off the laser beam.
2. Ensure that moving parts, e.g. robot arms, etc. are at a standstill and that they cannot be set in motion unintentionally.
3. Close the shutter.
4. Switch off the power supply.
5. Turn off the water supply.
6. Push down the release ring of the water connector with two fingers of one hand and pull out the cooling circuit hose with the other hand.
7. Disconnect all connections.
8. Unscrew the fastening screws or loosen the fastening claws.
9. Remove the device from the laser system.
10. Drain the cooling circuit lines completely by tilting the device.
11. Seal the connectors with the supplied sealing plugs.

7 Connectors

7.1 Overview of connectors

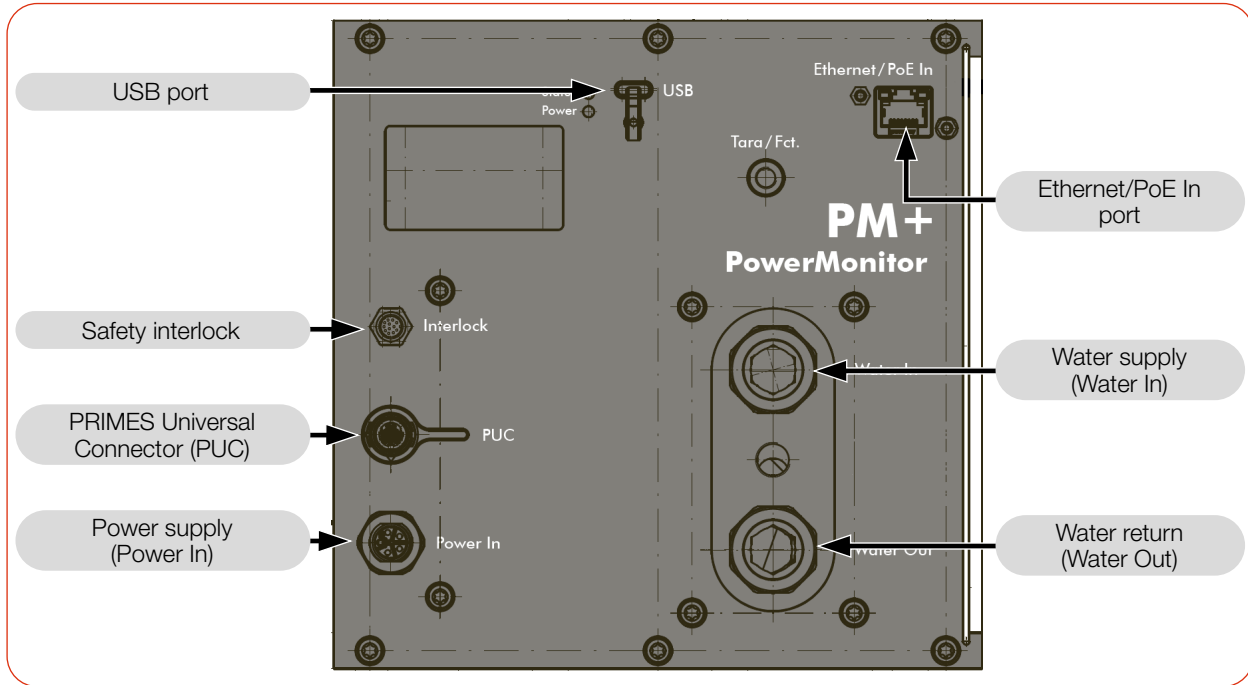

Fig. 7.1: Connectors on the PM+

7.2 Power supply

The following ports can be used for the power supply of the device:

- Power In (with PRIMES power supply)
- PoE (Power over Ethernet)
- USB (with USB-C power supply - not included in delivery)
- USB (with cable to PC)

The device starts automatically after connecting the power supply. When starting for the first time, initialization of the device takes about 1 minute. Do not remove cables during this time.

If the LaserDiagnosticsSoftware LDS is to be used for the measurement, a data connection to the PC/network must be set up. One of the following connections can be used for data transmission:

- Ethernet
- USB

Connection options:

Power supply	Data transmission	Chapter
Power In with PRIMES power supply	As stand-alone device (display on the device)	7.2.1 on page 26
USB	USB	7.2.2 on page 27
Power In with PRIMES power supply	USB	7.2.3 on page 28
	Ethernet	
Power over Ethernet (PoE)	Ethernet	7.2.4 on page 29
USB with power supply (not included in delivery)	Ethernet	7.2.5 on page 30

Tab. 7.1: Connection options

Combination of PoE for power supply and USB for data transmission not possible

Using PoE for power supply and USB for data transmission cannot be implemented in practice, since Ethernet has priority over USB. The data would be sent via Ethernet, not USB.

UPS (uninterruptible power supply) is not possible with dual power supply

Power supplies can be connected in parallel. However, the second power supply can not be used as a UPS (uninterruptible power supply).

If the supply cable of the active power supply is removed, the data connection will be disconnected and the interlock will be triggered. The device must be restarted.

7.2.1 Power supply via PRIMES power supply when used as a stand-alone device

Only use the provided PRIMES power supply.

- Power is supplied via the PRIMES power supply with $24\text{ V} \pm 5\%$ (DC).
- The measured values are shown on the display of the device.

Required components (included in delivery)

- PRIMES power supply

Connecting the PM+

- ▶ Connect the PRIMES power supply according to Fig. 7.2 on page 26.

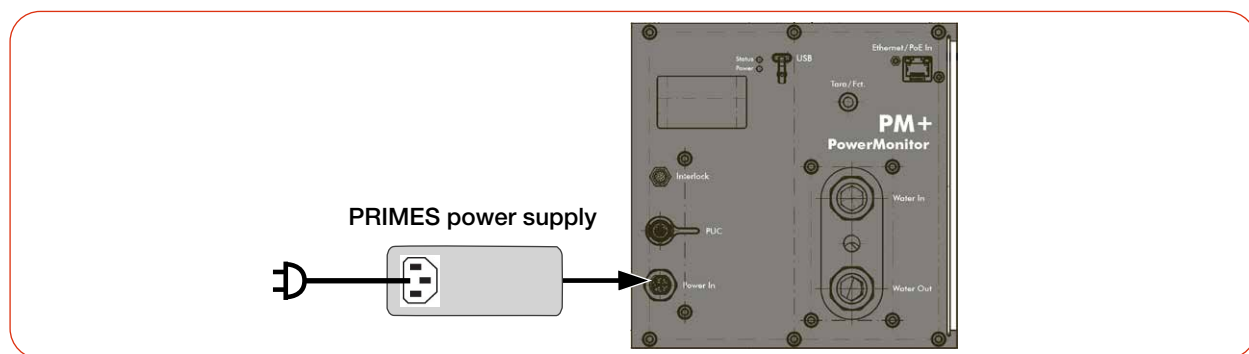

Fig. 7.2: Power supply via PRIMES power supply, display of the measured values on the device

7.2.2 Power supply via USB connection and communication with the PC via USB

Only use the provided USB connection cable.

- Power is supplied via the USB cable on the PC with max. 5 V (DC).
If further USB devices are connected to the PC, it may be necessary to connect the PRIMES power supply or establish the power supply via Power over Ethernet (PoE).
- Data is transferred via USB cable.

Required components (included in delivery)

- USB cable (C to A connector)

Connecting the PM+ to a PC

- ▶ Connect the cable according to Fig. 7.3 on page 27.

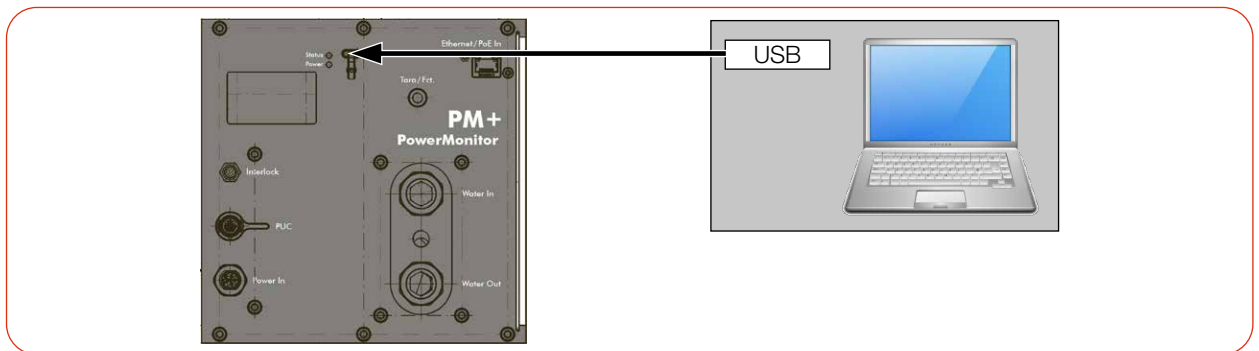

Fig. 7.3: Power supply via USB, data transfer via USB

7.2.3 Power supply via PRIMES power supply and communication with the PC via USB or Ethernet

Only use the PRIMES power supply and the provided cables.

- Power is supplied via the PRIMES power supply with 24 V ± 5 % (DC).
- Data is transferred via USB or Ethernet cable.

Required components (included in delivery)

- PRIMES power supply
- USB cable (C to A connector)
- Ethernet cable

Connecting the PM+ to a PC

► Connect the PRIMES power supply and the cable according to Fig. 7.4 on page 28 an.

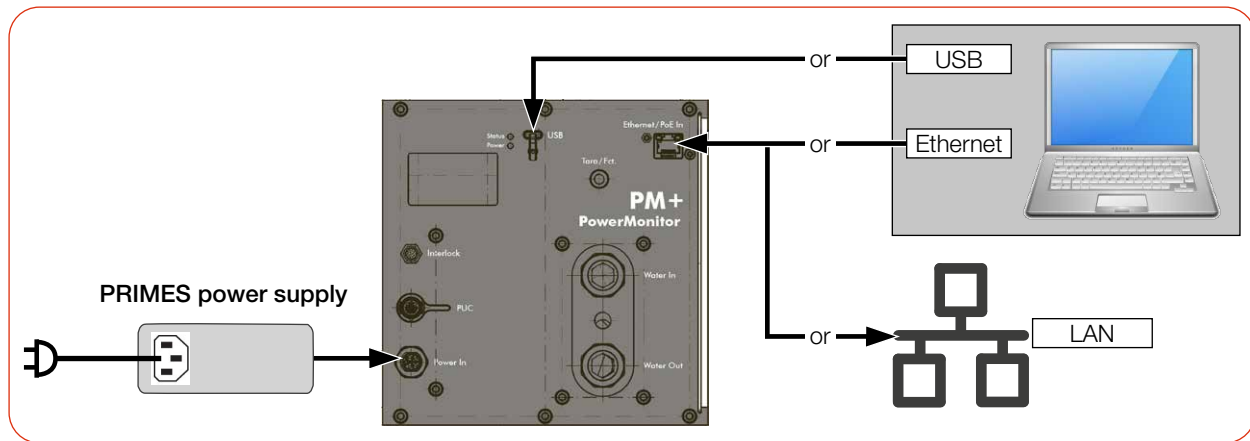

Fig. 7.4: Power supply via PRIMES power supply, data transfer via USB or Ethernet

7.2.4 Power supply via Power over Ethernet and communication with the PC via Ethernet

With the PoE port, the power supply with max. 24 V can be set up in 2 ways:

- with a PoE injector (midspan device),
- with a PoE capable Ethernet port e.g. on a switch (endspan device).
- Data is transferred via Ethernet cable.

Required components

Included in delivery:

- Ethernet cable

Not included in delivery:

- PoE Injector (Midspan Device)
- Second Ethernet cable on PoE injector

Connecting the PM+ to a PC

- ▶ Connect the cables according to Fig. 7.5 on page 29.



The device will not start if the two plugs on the PoE injector are reversed.

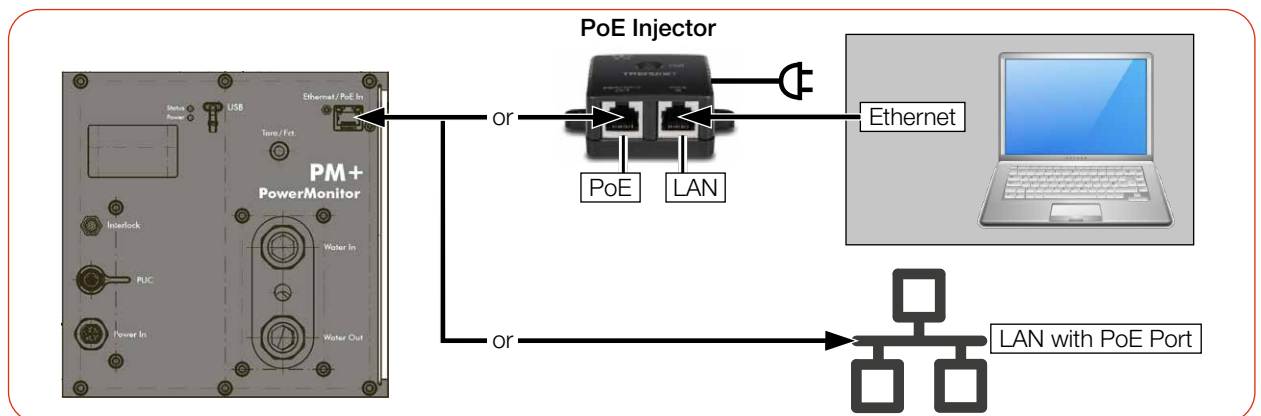

Fig. 7.5: Power supply and data transfer via PoE In

7.2.5 Power supply via USB-C power supply and communication with the PC via Ethernet

- Power is supplied via the USB-C power supply (not included in delivery) with max. 20 V (DC).
- Data is transferred via Ethernet cable.

Required components

Included in delivery:

- Ethernet cable

Not included in delivery:

- USB-C power supply

Connecting the PM+ to a PC

► Connect the power supply according to Fig. 7.6 on page 30.

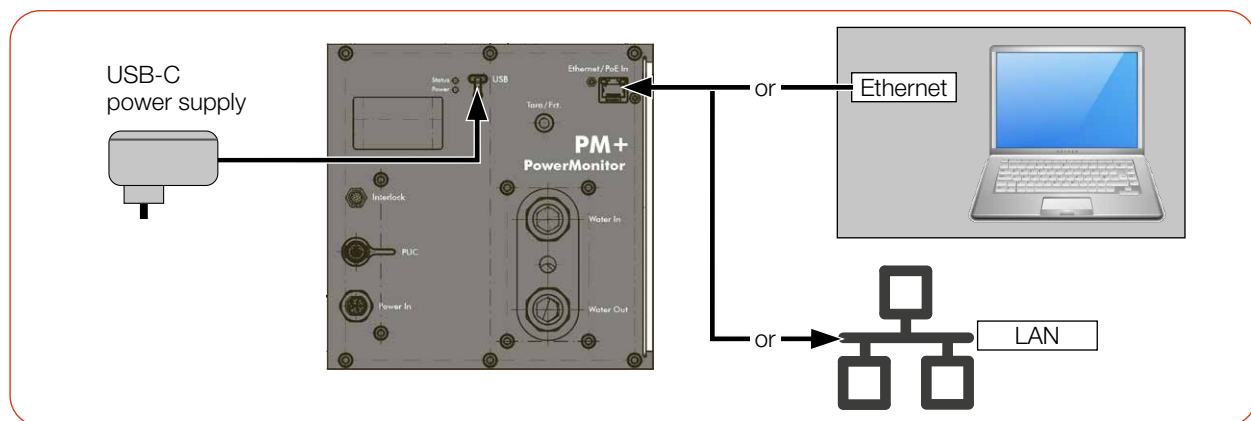

Fig. 7.6: Power supply via USB-C power supply, data transmission via Ethernet

7.3 Power In

The connector socket for the power supply is a 5-pin, L-coded M12 connector.

This connector is used for power supply with the PRIMES power supply.

Harting M12-P-PCB-THR-2PC-5P-LCOD-M-STR	Pin	Function
	1	+24 V ± 5 % (DC)
	2	Not connected
	3	GND
	4	Not connected
	5	FE (functional earth)

Tab. 7.2: Power In connector socket for the PRIMES power supply

7.4 Ethernet/PoE In

The PoE port is specified according to PoE standard IEEE 802.3af (802.3at Type1) Power Class 3 (Mid Power, 12.95 W).

This port can be used as an Ethernet or as a Power-over-Ethernet port:

- Ethernet port: The port can only be used for data transmission.
- PoE In port: The port can be used for power supply and data transmission via Power over Ethernet.

7.5 USB

USB port: connection type USB-C; version USB 2.0.



Note that a USB interface without additional interference suppression measures is not EMC-compliant. Therefore, in industrial environments with strong sources of interference, connection interruptions and data transmission disturbances may occur.

The Windows driver usbser.sys is used. It is part of the driver packages included in Windows.

If a PM+ is connected to a PC for the first time, this driver is automatically activated and the following message appears:



Setting up a device
We're setting up 'VCOM Port'.

Next:

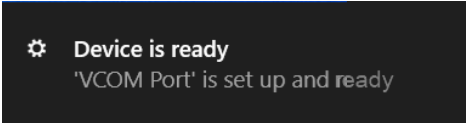

Device is ready
'VCOM Port' is set up and ready

From then on, every time such a device is connected, it will appear in the Device Manager as „USB Serial Device (COMxx)“.

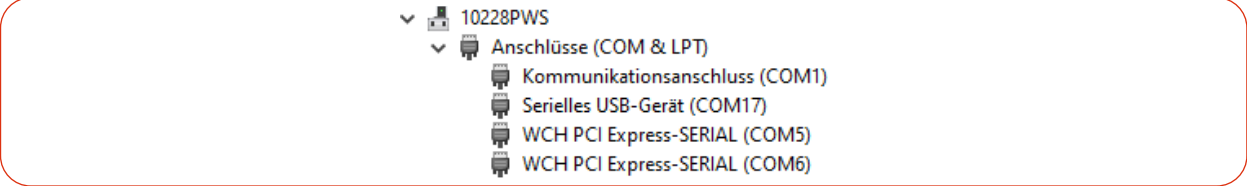

10228PWS
Anschlüsse (COM & LPT)
Kommunikationsanschluss (COM1)
Serielles USB-Gerät (COM17)
WCH PCI Express-SERIAL (COM5)
WCH PCI Express-SERIAL (COM6)

The driver is set up for the device as soon as the USB connector is used, even if this is only for the purpose of supplying power.

7.6 PRIMES Universal Connector (PUC)

The port serves as a PRIMES service interface.

7.7 Safety interlock (Interlock)

The device has two redundant safety circuits internally.



DANGER

Fire hazard; Damage/Destruction of the device

The safety interlock monitors the operating conditions of the device. The safety interlock offers potential-free switch contacts for integrating the device into an existing safety circuit.

- ▶ Connect the safety interlock of the laser control unit in such a way, that in the event of faulty operating conditions, the laser is switched off.
- ▶ Check that the safety interlock will switch off the laser properly in case of error.

Monitored operating conditions

The safety interlock protects the device by switching off the laser beam in the following cases:

- the cooling water flow is too low (Flow < 6.0 l/min)
- the cooling water temperature at the water supply (Water In) is too high (T_{in} > 40 °C)
- the temperature difference between water supply (Water In) and water return (Water Out) is too large (T_d > 40 K)
- the permitted temperature at the absorber of 70 °C is exceeded
- the shutter is not (completely) open

Pin assignment at + 24 V (External)

Pin assignment M8 plug 12-pin (Pin: view to plug on device; Color: wire color of cable)

	Pin	Color	Function
	1	Brown	COM 1
	2	Blue	NC: Connected with pin 1 in faulty operating conditions.
	3	White	NO: Connected with pin 1 when ready for operation.
	4	Green	COM 2
	5	Pink	NC: Connected with pin 4 in faulty operating conditions.
	6	Yellow	NO: Connected with pin 4 when ready for operation.
	7	Black	+ 24 V externally (DC)
	8	Grey	Ground for + 24 V externally (PIN 7)
	9	Red	Not connected
	10	Purple	Not connected
	11	Grey-Pink	Not connected
	12	Red-Blue	Not connected

Suitable ready-made cable: Binder 79-3808-52-12

Tab. 7.3: Pin assignment of the safety interlock connector

If the safety interlock is triggered, pin 1 and pin 2 (pin 4 and pin 5) are connected.

If the values correspond to the operating conditions, pin 1 and pin 3 (pin 4 and pin 6) are connected.

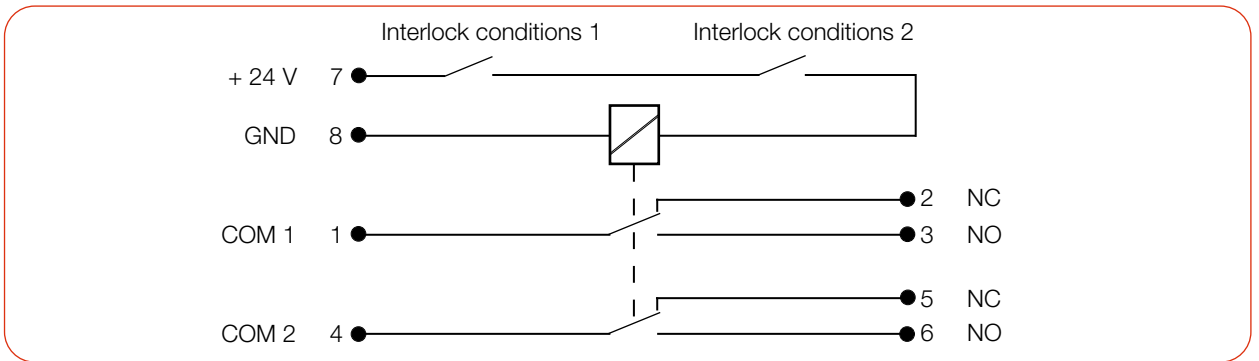

Fig. 7.7: Circuit diagram: Monitored operating conditions (Interlock conditions)
Device not ready for operation, Laser is off



Pin 7 and 8 must be connected for the safety interlock to be active.

If the cable socket is not connected and the safety interlock is thus not active, a warning message in the LaserDiagnosticsSoftware LDS is issued.

Required component

A suitable connection cable with a device plug and bare ends is included in the delivery.

7.8 Cooling circuit (Water In/Water Out)

DANGER

Fire hazard due to overheating of the device

If there is no water cooling or insufficient water flow, the device will heat up and may catch fire.

- ▶ Operate the device only with a connected water cooling system and a sufficient flow rate.

CAUTION

Eye and skin damage

If the cooling water hoses are disconnected while the water supply is on, high-pressure water may be sprayed into the eyes.

- ▶ Turn off the water supply before disconnecting the cooling water hoses.

7.8.1 Connect/remove cooling water hoses

The water connectors are sealed with plugs to prevent residual water from leaking out.

	<ol style="list-style-type: none"> 1. Push down the release ring of the hose connector with two fingers of one hand and pull out the sealing plug with the other hand. 2. Keep the sealing plugs for closing the water connectors at a later stage. <p>Connect cooling water hoses</p> <ol style="list-style-type: none"> 1. Connect the supply hose (Water in) and the return hose (Water out) by pushing the cooling water hoses into the hose connectors as far as they will go (approx. 2 cm). 2. Check whether the hose connections are tight. <p>Remove cooling water hoses</p> <ul style="list-style-type: none"> ▶ Push down the release ring of the hose connector with two fingers of one hand and pull out the cooling water hose with the other hand.
--	--

Fig. 7.8: Connect/remove cooling water hoses

7.8.2 Damage to the device

NOTICE

Damage/Destruction of the device

If the following requirements for the cooling circuit are not observed, the measuring device may be damaged.

- ▶ Observe the following requirements.

Water quality

The device can be operated with tap water as well as demineralized water.

An operation with strongly deionized water (DI-water, conductivity < 30 µS/cm) is only possible with appropriate connection parts (stainless steel) – we will be glad to advise you as necessary.

No dirt particles/fibrous sealants

When sealing the external thread with fibrous sealant (e.g. hemp or teflon tape, make sure that no sealant residue gets into the flow.

Large dirt particles or fibrous sealants may block internal cooling circuits. Therefore, please rinse the system thoroughly before connecting it.

Aluminum components

Do not operate the device on a cooling circuit in which aluminum components are installed. Otherwise, corrosion in the cooling circuit can occur, particularly when operating at high powers and power densities. In the long term, this will reduce the efficiency of the cooling circuit.

Condensates within the device

The device must not be operated in a condensing atmosphere. Check the environmental humidity levels to prevent condensates within and outside the device.

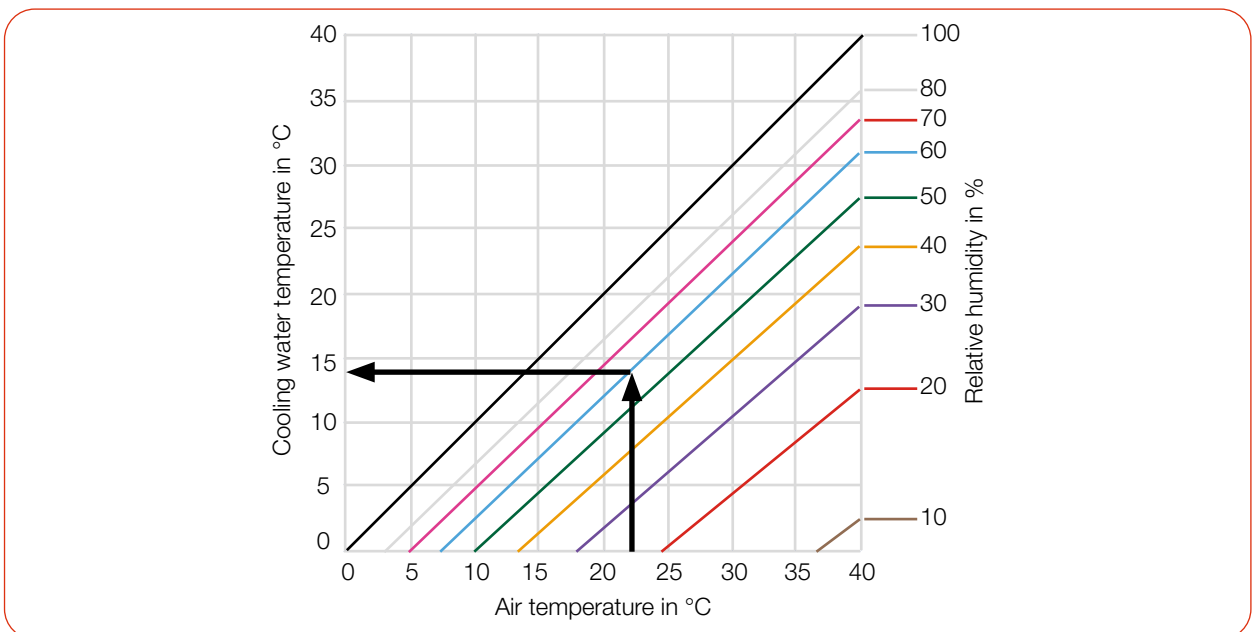

Tab. 7.4: Dew point diagram: The temperature of the cooling water must not be lower than the dew point

Example:

Air temperature: 22 °C

Relative humidity: 60 %

The cooling water temperature must not fall below 14 °C.

7.8.3 Avoid measurement inaccuracies

Antifreeze and additives

The heat capacity is one of the key parameters that is used in order to calculate the laser power. Therefore, do not operate the unit in a cooling circuit that contains antifreeze (or only after consultation with PRIMES).

Other additives - such as biocides and corrosion inhibitors - may be added to the cooling water up to a maximum concentration of 1 %.

Temperature fluctuations of the cooling water

It is important that the temperature of the inflowing water remains constant. The fluctuation of the temperature should not exceed 1 K per minute or 0.08 K per 5 seconds.

Observe the temperature display for the incoming water.

Alternatively, the power display can be observed for approx. 1 minute without the laser being switched on. The fluctuations give a first indication of the influence of the temperature fluctuations due to the chiller.

Gas bubbles in the cooling water

Gas bubbles in the cooling water can lead to measurement inaccuracies.

7.8.4 Damage to the flow meter

NOTICE

Damage/Destruction to the flow meter

The device uses a turbine or an oval wheel meter for flow measurement. This can be damaged by improper handling.

- Observe the following requirements.

Observe mounting position (oval wheel meter only)

The oval wheel axes of the oval wheel meter must be horizontal. Observe the mounting position according to chapter 6.2.2 „Possible mounting positions“ on page 18.

Observe flow direction

Reversing the flow direction will damage/destroy the flow meter during longer operation. If the flow direction is reversed, the display shows no flow or the laser power shown on the display or the LDS has a negative prefix.

Do not use compressed air

The flow meter is damaged by the use of compressed air in the cooling circuit. Do not use compressed air for emptying the cooling circuit.

Prevent freezing

Freezing of the cooling water must be prevented at any time by suitable precautions.

Limit cooling time

Only cool the device during measurements. PRIMES recommends starting the cooling approx. 2 minutes before the measurement and ending it approx. 1 minute after the measurement. The operating time has an influence on the service life of the flow meter.

No metal shavings/rust particles

There must not be any metal shavings/rust particles in the cooling water. The flow meter installed in the device is magnetic and attracts the metal shavings. This can lead to a build-up of debris and thus to measurement inaccuracies up to destruction of the flow meter.

7.8.5 Parameters of cooling water connection

Supply data	PM+ HP15
Hose diameter	16 mm
Water flow warning (warning threshold)	8 l/min
Min. cooling water flow (interlock threshold)	6 l/min
Max. cooling water flow	25 l/min
Recommended cooling water flow	10 – 15 l/min
Min. cooling water pressure	2 bar
Max. cooling water pressure	6 bar
Cooling water temperature T_{in}	Dew point temperature < T_{in} < 30 °C
Stability of the cooling water temperature	< 1.0 K per minute or 0.08 K per 5 seconds

Tab. 7.5: Parameters of cooling water connection

Recommended flow rate (rule of thumb)



The following rule of thumb can be used to determine the cooling water flow rate:

Per 1 kW laser power, a flow rate of approx. 1 l/min cooling water is recommended.

Example:

At 10 kW laser power, this corresponds to a flow rate of 10 l/min.

Observe that the cooling water flow must not be below the warning threshold according to Tab. 7.5!

Temperature increase of the cooling water

The temperature increase of the cooling water as a function of the laser power and the flow rate is calculated as follows:

Temperature increase: ΔT [K]

Laser power used: P [kW]

Flow rate: Q [l/min]

$$\Delta T (K) = 14.3 \frac{l \cdot K}{kJ} \cdot \frac{P (kW)}{Q \left(\frac{l}{min} \right)}$$

Formula 7.1: Calculation of the temperature increase of the cooling water as a function of the laser power and the flow rate

Example:

At 7 kW laser power and a flow rate of 9.5 l/min, the temperature of the cooling water increases by 10.5 °C.

7.8.6 Pressure loss

Usually, a primary pressure of 2 bar at the water supply (Water In) of the device (with unpressurised outlet) is sufficient to ensure the necessary flow rate.

With the following diagram, the minimum pressure required at the cooling water supply (Water In) of the unit can be determined.

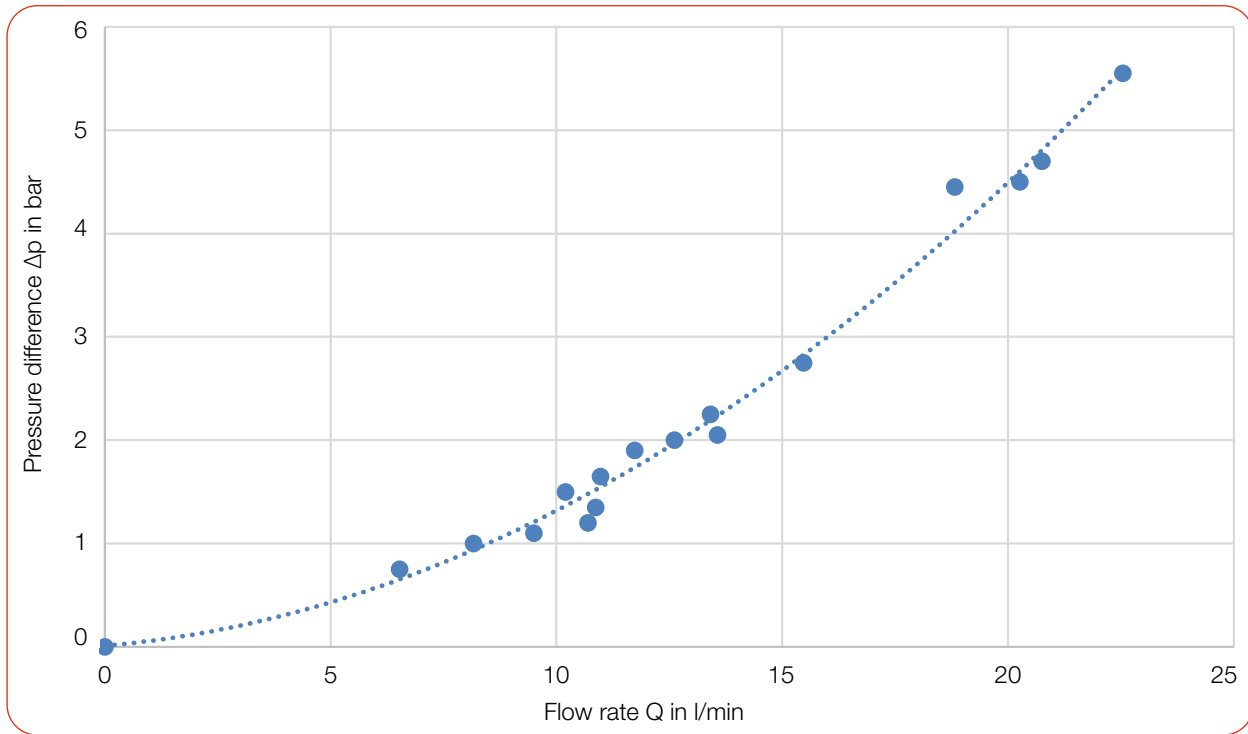

Tab. 7.6: Pressure loss diagram PM+ HP15

8 Software installation

8.1 Install LaserDiagnosticsSoftware LDS



The LDS is included in delivery. PRIMES will also be happy to provide you with a link to download the current version. Please contact your sales partner or contact us by e-mail: support@primes.de

1. Please ensure:
 - System requirements are met.
 - You have administrator rights.
2. Close all programs on your PC.
3. Insert the PRIMES USB flash drive into your PC and open the directory. In the standard configuration, Windows automatically opens the removable storage device.
4. Double-click the LDS_Setup.exe file to start the installation.
5. Follow the instructions in the screen.
 - ➔ If no other location is specified, then the main program **LDS.exe** will be copied into the directory **C:\Programs\Primes\LaserDiagnostics-Software**.

System requirements:

- Intel Pentium Core i3 or better
- Windows 10 (64-bit version)
- At least 4 GB RAM; 8 GB RAM recommended
- Display resolution: Full HD (1 920 x 1 080) at 100 % scaling
- A USB port type A or Ethernet port for connecting the measuring device

8.2 Connect PRIMES device to a PC

Choose one of the following options to establish a connection between the PRIMES device and the PC.

The IP address of the PRIMES device can only be changed once this connection has been established (see section „Change IP address of a connected device“ on page 43).

8.2.1 Integration of a PRIMES device into a network

Within the PRIMES device, the option DHCP (Dynamic Host Configuration Protocol) is activated by default.

- The Primes device is assigned an IP address by a DHCP server.
- The device communicates via the IPv4 internet protocol. The internet protocol IPv6 is not supported.

8.2.2 Direct connection of a PRIMES device to a PC

Administrator rights are necessary in order to set the IP address.

1. In **Windows > Control panel > Network and Sharing Center**, assign an IP address to your PC that is within the same address range as the static IP address of your PRIMES device (e.g. 192.168.116.xyz).
 - The static IP address of your PRIMES device is located on the identification plate or is shown on the display (status page).
 - The first 3 number blocks must be identical, the last number block (0-255) can be freely selected.
 - The static IP address of the Primes device on the identification plate must not be used for the PC.
2. The subnet mask is to be set to 255.255.255.0.

9 Measuring

9.1 Warning messages



DANGER

Serious eye or skin injury due to laser radiation

During the measurement the laser beam is guided on the device. This causes scattered or directed reflection of the laser beam (laser class 4).

The device must not be operated without taking the following precautions:

- ▶ Before switching on the laser, open the shutter of the device.
- ▶ Wear **safety goggles** adapted to the power, power density, laser wave length and operating mode of the laser beam source in use.
- ▶ Wear suitable **protective clothing** and **protective gloves**.
- ▶ Protect yourself from laser radiation by separating protective devices (e.g. by using appropriate shielding).



DANGER

Serious eye or skin injury due to laser radiation

If the device is moved from its aligned position, increased scattered or directed reflection of the laser beam occurs during measuring operation (laser class 4).

- ▶ Mount the device so that it cannot be moved by an unintended push or a pull on the cables or hoses.



DANGER

Fire hazard; Damage/Destruction of the device

The safety interlock monitors the operating conditions of the device. The safety interlock offers potential-free switch contacts for integrating the device into an existing safety circuit.

- ▶ Connect the safety interlock of the laser control unit in such a way, that in the event of faulty operating conditions, the laser is switched off.
- ▶ Check that the safety interlock will switch off the laser properly in case of error.

NOTICE

Damage/Destruction of the device

The deflection mirror can be damaged if the power density is too high.

- ▶ Make sure the focal plane is not located on the deflection mirror.
- ▶ Make sure that the permitted power density on the deflecting mirror is not exceeded.

9.2 Preparing measurement readiness

1. Observe the warning messages according to chapter 9.1 on page 40.
2. Connect the safety interlock of the laser control to the device.
3. Connect the device to the power supply.
 - 👁 The white Power LED must light up.
 - 👁 Wait until the display lights up.
 - 👁 The Status LED flashes red after a short time.
4. Turn on the water cooling.
 - 👁 After a few seconds, the red Status LED must turn off.

After approx. 2 minutes, the device temperature and the cooling water temperature are in equilibrium.

5. The PM+ is ready for measurement.

9.3 Measuring with the PM+ as a stand-alone device

The PM+ can also be used to measure without a PC. The measured values are shown on the display of the device. The display shows the following measured values:

Display	Meaning
W	Laser power in W
Flow	Flow rate of the cooling water in l/min
Tin	Cooling water temperature at the water supply (Water In) in °C
Td	Temperature difference between water supply (Water In) and water return (Water Out) in Kelvin

4399 W

Flow: 10.8297
Tin: 14.17 °C
Td: 9.124 K

Tab. 9.1: Abbreviations on the display

Get ready for measurement

1. Prepare the device according to chapter 9.2.

Determine zero level

The Tara/Fct. button can be used to reset the measured value of the power display to zero. PRIMES recommends the following procedure before each measurement:

2. Press the Tare/Fct. button (> 0.5 s) to reset the power display to zero.

Start measurement

3. Observe the max. laser power as a function of the beam diameter according to Appendix A on page 62.
4. Open the shutter completely.
5. Switch on the laser.
 - ➔ The measured laser power is displayed after about 2 seconds.
After about 20 seconds the display reaches about 99 % of the final value.
6. Switch off the laser.
7. Close the shutter completely.

9.4 Measuring with the LaserDiagnosticsSoftware LDS

This chapter describes measurements with the LDS. For a detailed description of the software installation, file management and evaluation of the measured data, please refer to the separate operating manual “LDS”.

9.4.1 Connect/disconnect the device with the LDS

Switch on the device and connect it to the LDS

1. Prepare the device according to chapter 9.2 „Preparing measurement readiness“ on page 41.
2. Start the LDS by double-clicking on the program icon **LD** in the start menu group or on the desktop icon.

👁 The start screen appears.

3. Select the operating mode **Measure**.

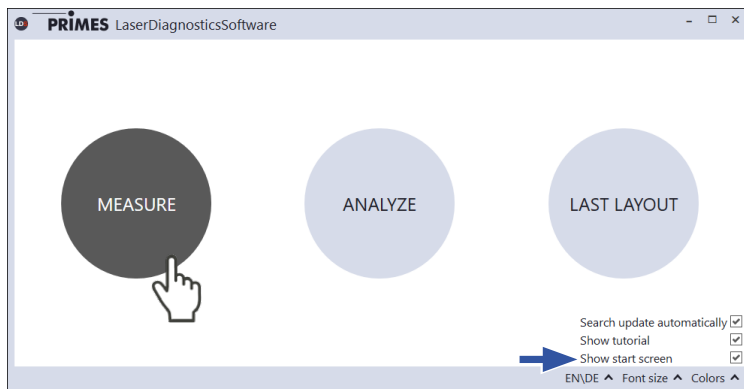

If the **Show start screen** option is disabled or the window **Connections** is closed:

- ▶ Click the **Devices** tab and then on the **+ Connect to device** button.



👁 The **Connections** window appears.

4. Click on the desired device.
5. Click the **Connect to device** button.

If the device does not appear when connected to USB:

- ▶ Click the **Search for PRIMES USB** button.

If the device does not appear when connected to Ethernet:

- ▶ Click the **Search the network** button.

If the device still does not appear in the **Connections** window, see chapter 10.2 „Connection errors with the LDS“ on page 51.

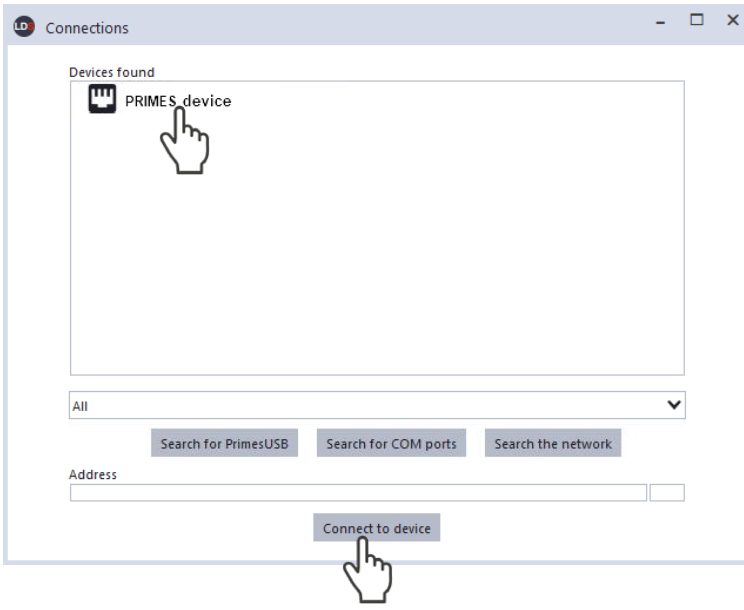

Change IP address of a connected device

A static IP address is stored within the device and the function **Use DHCP** is activated. When establishing a connection, the device will first wait to be assigned a suitable IP address via DHCP. If this proves unsuccessful, it will revert to the factory static IP address.

If **Use DHCP** is disabled, the device will directly use the static IP address. As a result, the connection can be established faster.

For a connected device, both the IP address and the activation of DHCP can be changed.

Change the IP address of a device as follows:

1. Click the **Devices** tab.
2. Right-click on the device and select the **Device settings** menu point.
3. Enter the desired IP address in the **Static IP address** input field.
4. Deactivate **Use DHCP**.
5. Confirm the entry with **OK**.

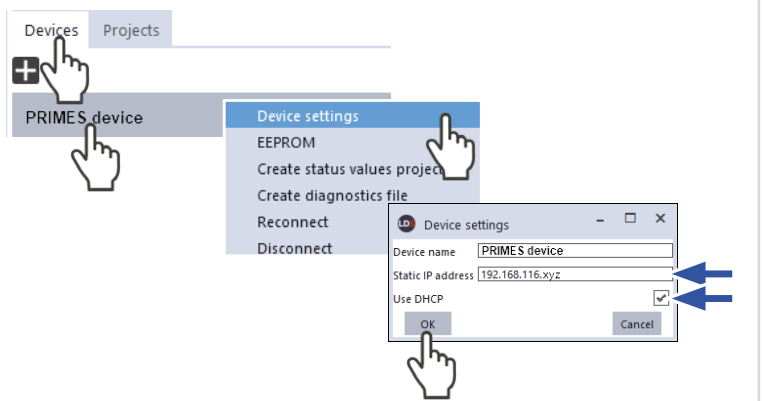

 The **Confirmation** window appears.

6. In the **Confirmation** window, place a check mark at **Acknowledge** and click **OK**.
7. Switch the device off and on again.

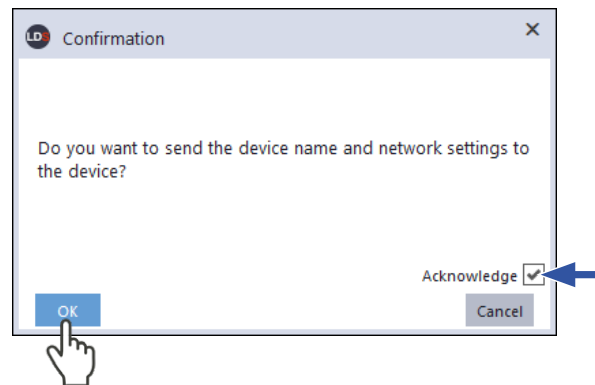

 If the PRIMES device is connected directly to a PC (without network), the IP address of the PRIMES device and the PC must be within the same address range.

If a static IP address is selected that is outside the address range of the PC and DHCP is also deactivated, the device can no longer be addressed.

To reconnect the PRIMES device, the IP address of the PC has to be changed (see chapter 8.2.2 „Direct connection of a PRIMES device to a PC“ on page 39).

Disconnect from the LDS and switch off the device

1. Click the **Devices** tab.
2. Right-click on the device and select the **Disconnect** menu point.
 - ➔ The device is disconnected from the LDS.
3. Switch off the power supply by disconnecting the cable.
4. If applicable, disconnect the electrical connections.

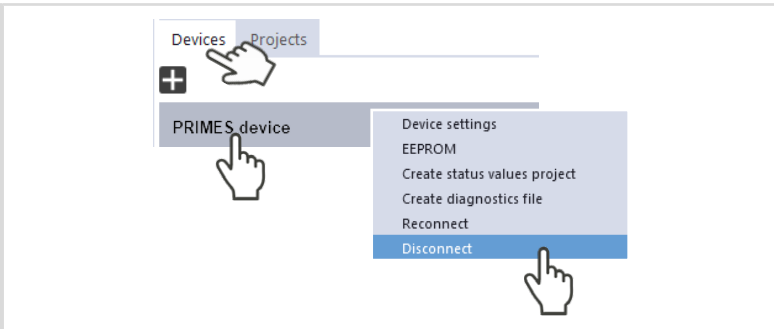

9.4.2 General information about working with the LDS

Enter user-defined device name

If you want to assign a user-defined device name to a device, proceed as follows:

1. Click the **Devices** tab.
2. Right-click on the device and select the **Device settings** menu point.
3. Enter the desired device name in the **Device name** input field (max. 18 characters).
4. In the **Device settings** window, confirm the entry with **OK**.

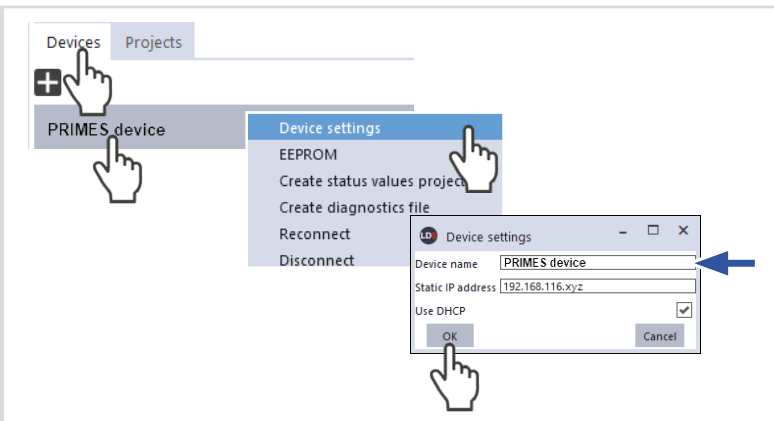

- 👁 The **Confirmation** window appears.
5. Place a check mark at **Acknowledge** and click **OK**.
 6. Switch the device off and on again.
 - ➔ The device name is displayed in the **Connections** window.
 - ➔ After connecting, the device name is displayed in the **Devices** tab.

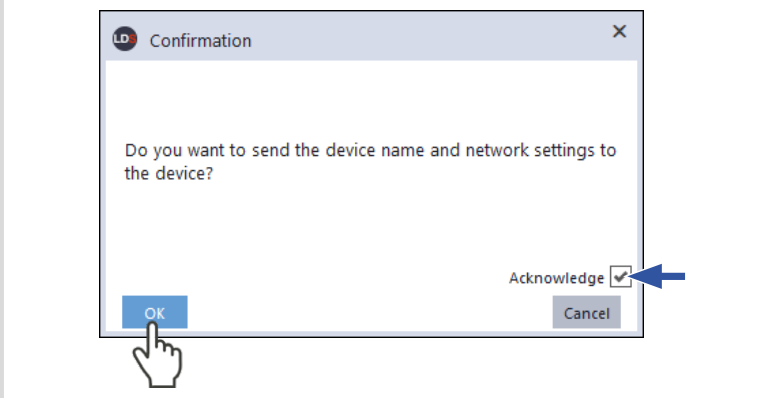

Enter parameters and activate

Confirm an entered parameter value by pressing the Enter key:

1. Enter the desired value in the input field.
- 👁️ The background color of the input field changes to blue.
2. Confirm the entry by pressing the Enter key.
- 👁️ The field returns to its original background color.

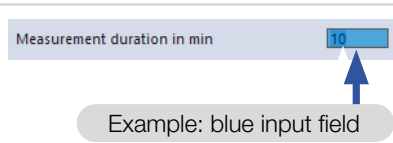

Saving options

The LDS offers 2 different options for saving. They differ by the storage location.

Save data with asterisk (*) to a file / load from a file:

All data marked with an asterisk in the **Device control** menu can be saved to a preset file with the extension **.pre** on the PC.

- ▶ To save a configuration, click the icon
- ▶ To load a configuration, click the icon

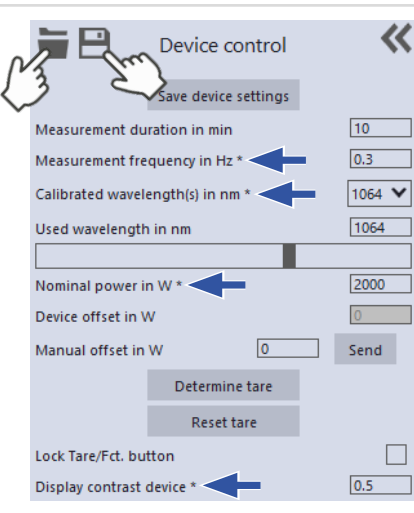

Save data with an asterisk (*) in the EEPROM of the device:

All options marked with an asterisk in the **Device control** menu can be saved in the EEPROM in the device.

In this case, the settings will be retained even if the device is switched off or disconnected from the power supply.

- ▶ Click the **Save device settings** button.

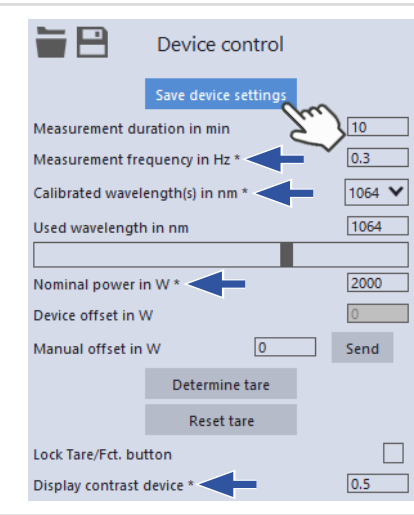

9.4.3 Open power measurement mode

👁️ The PM+ is displayed as a connected device.

1. Click on the connected device.

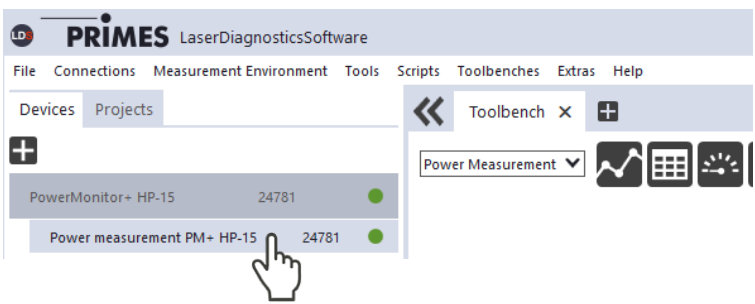

👁️ The corresponding *Device control* opens.

👁️ The *Power Measurement* toolbench opens.

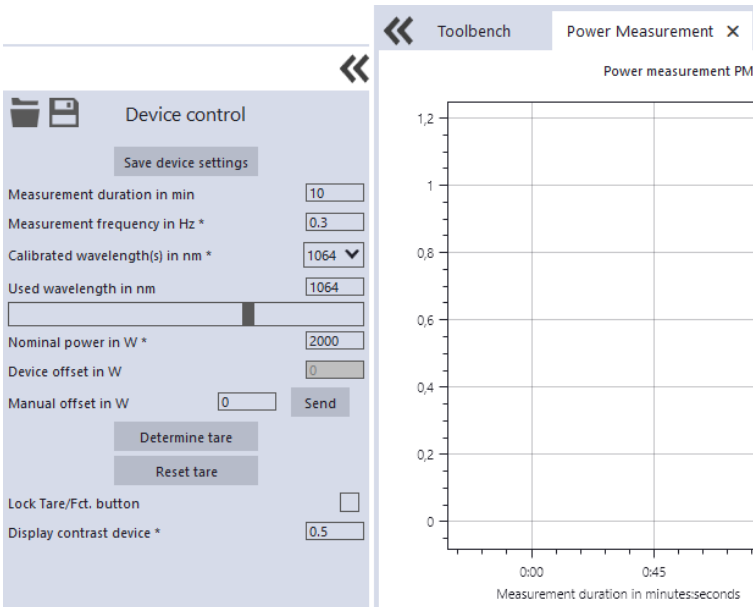

9.4.4 Perform power measurement

Settings in the device control

Option	Explanation
Measurement duration in min	<p>▶ Enter a value in the input field.</p> <p>Without input, the power is measured permanently.</p>
Measurement frequency in Hz	<p>▶ Enter a value in the input field.</p> <p>The value must be between ≥ 0.1 Hz and ≤ 3 Hz.</p>
Calibrated wavelength(s) in nm	<p>The PM+ can measure the laser power of lasers with the following wavelength ranges:</p> <p>450 nm, 515 - 532 nm, 800 – 1 100 nm, 10 600 nm</p> <p>The calibrated wavelengths of 1 064 nm (included) or 515 nm, 10 600 nm (optional) can be selected.</p> <ol style="list-style-type: none"> Select the Calibrated wavelength(s) in nm from the drop-down list. Click the Save device settings button. <p>The absorption behavior of the absorber is wavelength-dependent. By selecting the appropriate calibrated wavelength, the measurement accuracy is improved.</p>

Tab. 9.2: Settings in the device control

Option	Explanation
<i>Used wavelength in nm</i>	The entry is only for documentation purposes. Use one of the following options: <ul style="list-style-type: none"> ▶ Enter a value in the input field. ▶ Use the slider below the input field.
<i>Nominal power in W</i>	The entry is only for documentation purposes. <ul style="list-style-type: none"> ▶ Enter a value in the input field.
<i>Device offset in W</i>	The offset value (tare) shown on the display of the device is displayed.
<i>Manual offset in W</i>	<ul style="list-style-type: none"> ▶ Enter a value in the input field. <p>The offset value must be between $> (-300 \text{ W})$ and $< (+1\ 000 \text{ W})$. The offset value is only taken into account in the LDS.</p> <ul style="list-style-type: none"> ▶ Click Send. <p>The entered manual offset value is added to the offset value stored in the device.</p>
<i>Determine tare</i>	<ul style="list-style-type: none"> ▶ Click Determine tare. <p>The offset value is determined and set in the LDS.</p> <ul style="list-style-type: none"> ▶ Click Send. <p>The offset value stored in the device is overwritten.</p>
<i>Reset tare</i>	The offset value is reset in the LDS and on the device.
<i>Lock Tara/Fct. button</i>	<ul style="list-style-type: none"> ▶ Activate the check mark. <p>The Tara/Fct. button on the device can no longer be used for taring. It is still possible to switch cyclically through the screens of the display.</p>
<i>Display contrast device</i>	<ol style="list-style-type: none"> 1. Enter a value in the input field. The value must be between > 0 and < 1. 2. Click the Save device settings button. <p>The value remains even after restarting the device or without using the LDS.</p>

Tab. 9.2: Settings in the device control

Determine device offset (Tare)

To determine the device offset, the device must go through a thermalization time.

1. Run the cooling water for approx. 2 minutes.
 - ➔ After approx. 2 minutes, the device temperature and the temperature of the cooling water are in equilibrium.
2. With the laser turned off, click **Start**.
3. Click **Determine tare**.
 - ➔ The offset value is determined and stored in the LDS.
- 👁 The display of the laser power is automatically corrected with the stored offset value.
4. Click **Send**.
 - ➔ The offset value stored in the device is overwritten.

Alternatively, the device offset can also be reset directly on the device by pressing the Tare/Fct. button (> 0.5 s). The **Lock Tare/Fct. button** option must not be activated for this.

5. Starten Sie ein Messung.

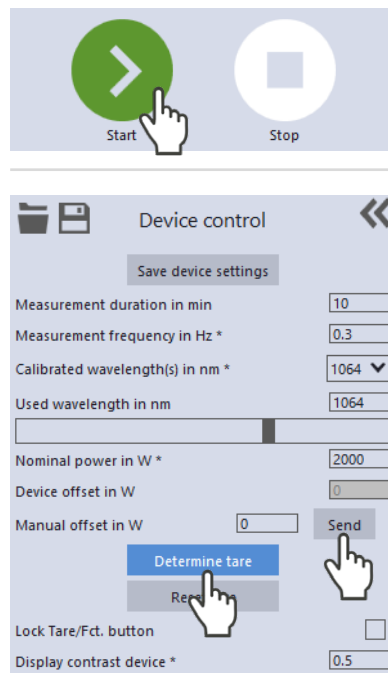

Start measurement

1. Observe the max. laser power as a function of the beam diameter according to Appendix A on page 62.
2. Open the shutter completely.
3. Switch on the laser.
4. Click the **Start** button.
 - 👁 The progress of the measurement is displayed.
5. If you have not entered a measuring duration, click the **Stop** button.
 - ➔ The measurement is finished.
6. Switch off the laser.
7. Close the shutter completely.

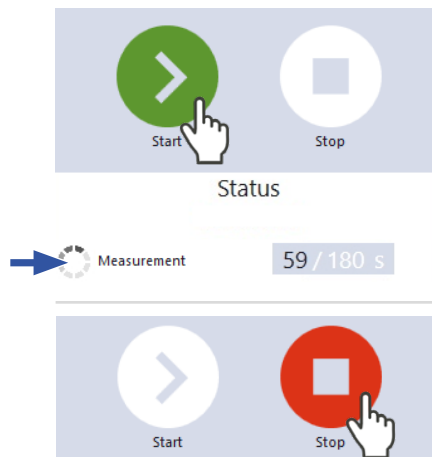

9.4.5 Measurement results display

👁️ The measurement results are shown during the measurement in the opened **Power Measurement** tool.

The displayed parameters can be adjusted by clicking the gear icon ⚙️. For example, **Advanced view**. The view changes to an extended display of the measured parameters.

A detailed description of the tools and the assessment of the measuring results can be found in the separate operating manual for the LDS.

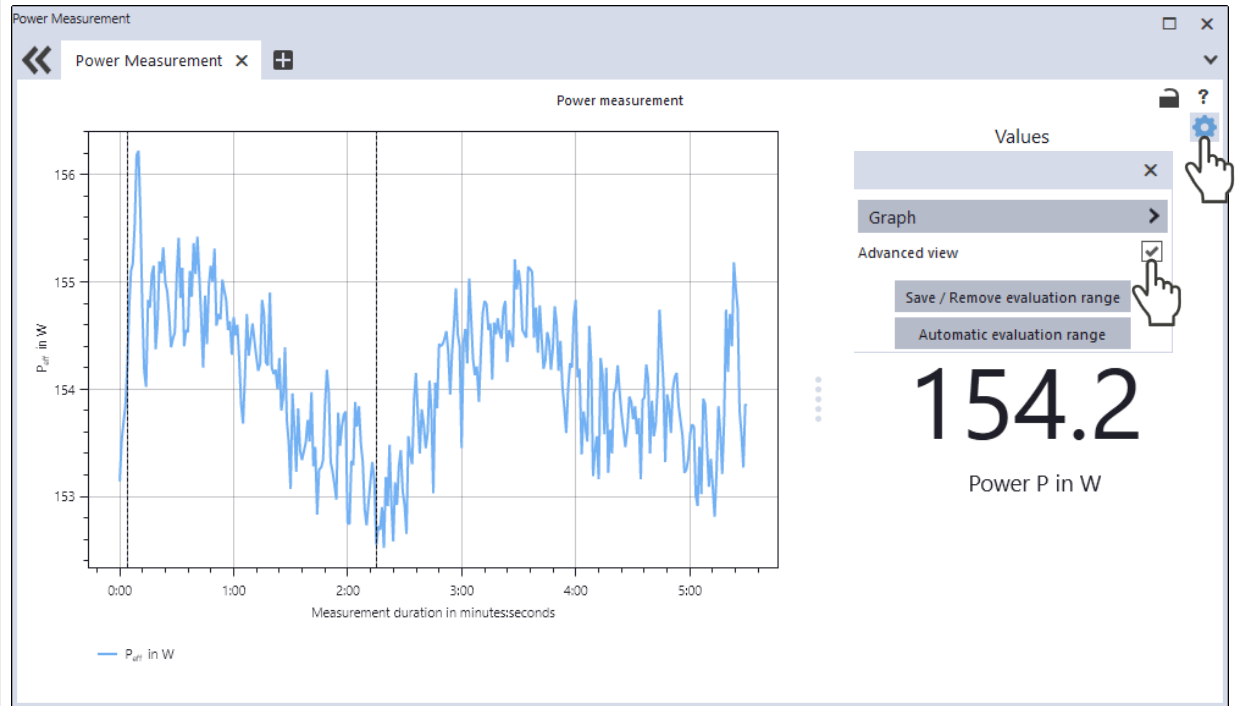

Advanced view

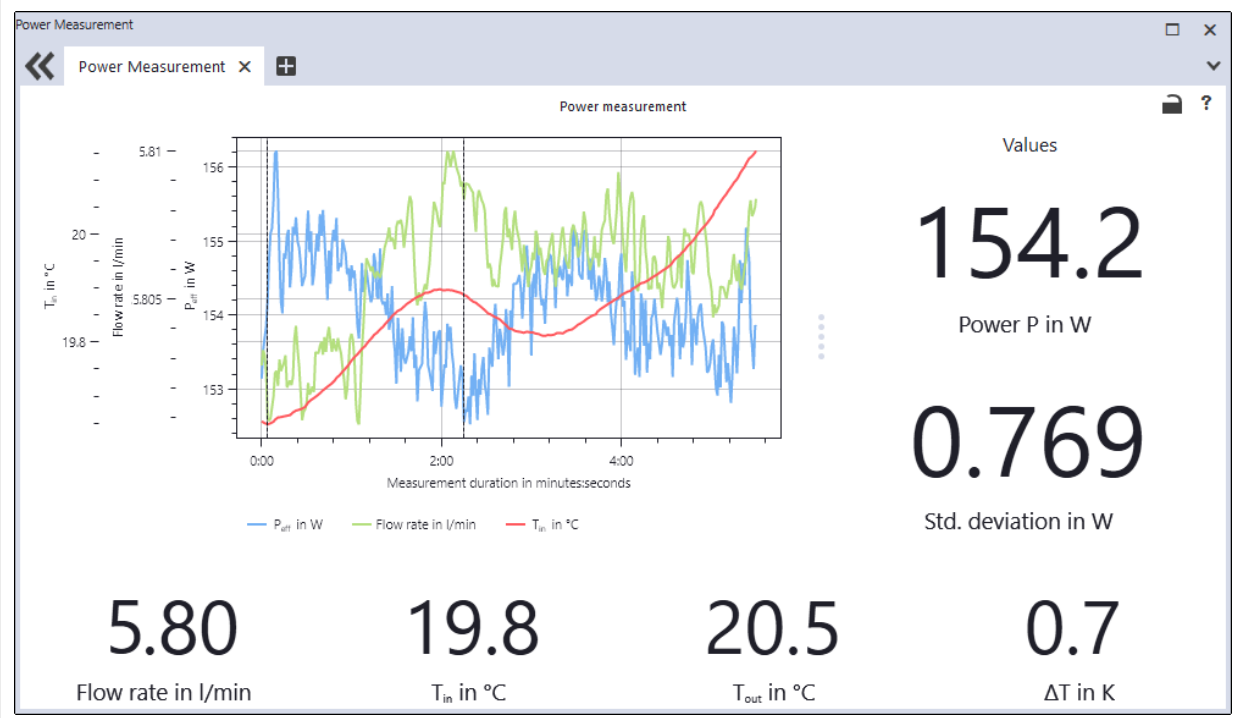

10 Troubleshooting

10.1 Messages in the LDS during measurement

If problems occur during a measurement, the LDS displays them in different categories and different colors.

<p>Note</p> <p>Notes provide assistance in interpreting the measurement results and are displayed in a blue window.</p> <p>Use one of the following options:</p> <ul style="list-style-type: none"> ▶ Click on the warning triangle in the footer to display / hide the window. ▶ If applicable, click the Next message button to display more messages of the same category. ▶ Click the Confirm button to remove the displayed message. 	
<p>Warning</p> <p>Non-safety-critical problems that influence the quality of the measurement results, for example, are displayed in a yellow window.</p> <p>Use one of the following options:</p> <ul style="list-style-type: none"> ▶ Click on the warning triangle in the footer to display / hide the window. ▶ If applicable, click the Next message button to display more messages of the same category. ▶ Click the Confirm button to remove the displayed message. 	
<p>Device error</p> <p>Device errors that can result in damage of the device are displayed in an orange window.</p> <p>In this case, proceed as follows:</p> <ol style="list-style-type: none"> 1. Fix the problem. 2. Click the Confirm button to remove the message. <p>👁 The message disappears. If the problem is not fixed, then the message appears again shortly afterwards.</p> <ol style="list-style-type: none"> 3. Do not proceed with the measurement until the problem is solved. 	
<p>Safety critical note</p> <p>Safety-critical problems that can result in damage/destruction of the device are displayed in a red window.</p> <p>In this case, proceed as follows:</p> <ol style="list-style-type: none"> 1. Fix the problem immediately. 2. Click the Confirm button to remove the message. <p>👁 The message disappears. If the problem is not fixed, then the message appears again shortly afterwards.</p> <ol style="list-style-type: none"> 3. Do not proceed with the measurement until the problem is solved. 	

10.2 Connection errors with the LDS

10.2.1 Ethernet connection errors

Error	Possible cause	Solution
The Ethernet connection between the device and the LDS cannot be established.	The firewall may block the connection between the device and the LDS.	The UDP port should be enabled by a system administrator. ▶ In Windows > Control panel > Firewall , enable the UDP port 20034.
	The IP address of the PC is not within the range of the device.	Administrator rights are necessary in order to set the IP address. ▶ Set the IP address according to chapter 8.2.2 „Direct connection of a PRIMES device to a PC“ on page 39.
	If several network cards or a USB3-to-Ethernet card are installed in the PC, the connection between device and LDS may be blocked by the selection of the wrong network card.	<ol style="list-style-type: none"> Select the appropriate network card in the Connections > All window.  The device is displayed in the Connections window. <ol style="list-style-type: none"> Click on the device. Click the Connect to device button.

Tab. 10.1: Ethernet connection errors

10.2.2 USB connection errors

Error	Possible cause	Solution
The USB connection between the device and the LDS cannot be established.	No USB connection has been established.	▶ Connect the USB port on the device and on the PC with the USB cable.
The device does not turn on when connected to the PC via USB.	The USB interface on the PC cannot supply the PM+ with sufficient power.	▶ Connect the PRIMES power supply according to chapter 7.2.1 on page 26.

Tab. 10.2: USB connection errors

10.3 Red flashing Status LED without an error message on the display

If the Status LED flashes red and no warning triangle is shown on the display, then:

- either the shutter is not completely open or
- the temperature at the absorber is too high (> 70 °C).

The safety interlock has been triggered.

10.4 Warning or error message on the display

Display of a warning or error message	
<p>A warning triangle is shown on the display. At the same time, the Status LED lights up/flashes.</p> <p>The possible cause is shown in the warning screen (change screen by briefly pressing the Tara/Fct. button).</p> <p>Warning message</p> <p>The Status LED lights up yellow.</p> <p>Error message</p> <p>The safety interlock has been triggered.</p> <p>The Status LED flashes red.</p>	



10.4.1 Warning message (Status LED lights up yellow)

Display	Possible cause	Solution
$\approx \dot{V} < 8.0 \frac{\text{l}}{\text{min}}$	The cooling water flow is too low ($\dot{V} < 8.0 \text{ l/min}$).	Increase the flow rate. There is a risk of the device overheating.
	The fluctuations of the flow rate of the cooling water are too high ($> 1.5 \%$).	Read the power value when the fluctuations have decreased. Check the pump. There should be no air bubbles in the cooling water.
 or 	The cooling water temperature at the water supply (Water In) is too low ($T_{in} < 15 \text{ °C}$).	Increase the temperature of the cooling water or use a different cooling system. There is a risk that the device will be damaged by condensation water.
	The cooling water temperature at the water supply (Water in) is too high ($T_{in} > 30 \text{ °C}$).	Check the cooling system. There is a risk of the device overheating.
	The temperature fluctuations at the water supply (Water In) are too high ($> 1.0 \text{ K/min}$).	High temperature fluctuations increase the measurement uncertainty of the device. Read the power value when the temperature fluctuations have decreased. In general, a large volume of water in the cooling circuit provides a small gradient (increase water tank volume).
	The temperature difference between the water supply (Water In) and the water return (Water Out) is too high ($T_d > 35 \text{ K}$).	Increase the flow rate or reduce laser power. There is a risk of the absorber overheating.
Without error “no warning” is displayed.		

Tab. 10.3: Warning messages (Status LED lights up yellow)

10.4.2 Error message (Status LED flashes red)

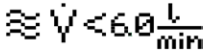
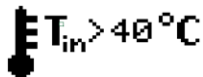
The safety interlock has been triggered.

Display	Possible cause	Solution
	The cooling water flow is too low ($V < 6.0$ l/min).	Check the cooling circuit and the direction of the water flow through the device. Increase the flow rate. There is a risk of damage to the device.
	The cooling water temperature at the water supply (Water In) is too high ($T_{in} > 40$ °C).	Check the cooling system. There is a risk of the device overheating.
	The temperature difference between water supply (Water In) and water return (Water Out) is too high ($T_d > 40$ K).	Check the laser power. Reduce the power or increase the flow rate. There is a risk of damage to the device.
Without error "no warning" is displayed.		

Tab. 10.4: Error messages (Status LED flashes red)

10.5 Other errors

Error	Possible cause	Solution
The device shows no flow. The displayed laser power on the display or the LDS has a negative prefix.	The flow direction has been reversed.	Reversing the direction of flow will damage/destroy the flow meter during longer operation. ▶ Connect the water supply (Water In) and the water return (Water out) according to the markings on the device.

Tab. 10.5: Other errors

11 Maintenance and service

11.1 Maintenance intervals

The operator is responsible for determining the maintenance intervals of the measuring device.

PRIMES recommends a maintenance interval of 12 months after initial operation for inspection and calibration.

If the device is used sporadically (less than once a day), the maintenance interval can be extended up to 24 months.

Please note that the safety and warning functions of the device must be checked regularly.

11.2 Cleaning the device surface

1. After a measurement let the device cool down for an adequate period of time.
2. Clean the device surface with clean and oil-free compressed air.
3. Close all device openings.
4. For further cleaning, use a mixture of distilled water and isopropanol in a ratio of approx. 5:1.
Use lint-free cleaning cloths that do not cause scratches.
5. If these steps are not sufficient, please contact PRIMES or your PRIMES distributor.

11.3 Clean/replace sieve in the water filter

NOTICE

Damage/Destruction of the device

If the fastening screw of the water filter is not countered, the cooling water hoses in the unit may be twisted and damaged. This can cause cooling water to leak into the device.

- ▶ When opening the water filter cap (AF 23), counter the fastening screw with a wrench (AF 32).

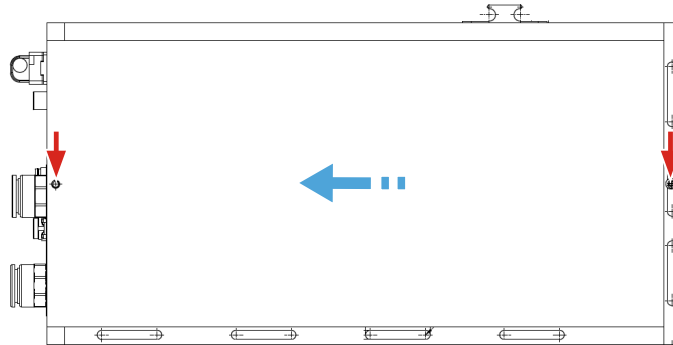

Fig. 11.1: Removing the side panel (Side view right)

1. Place the device on its bottom side (shutter faces upwards).
2. Unscrew the 2 fixing screws on the right side of the housing (red arrows).
3. Carefully slide the side panel in the direction of the blue arrow to remove it.
4. Counter the fastening screw (AF 32) and unscrew the the water filter cap (AF 23).
5. Remove the sieve.
6. Clean or replace the sieve. (Replacement sieve: Order number 160-015-040)
7. Put the sieve back in place.
8. Counter the fastening screw (AF 32) and screw in the water filter cap (AF 23). Do not overtighten the water filter cap.
9. Place the side panel in the guide rails and push it back into the housing as far as it will go.
10. Check that the side panel is securely seated. The side panel must lie against the housing without gaps.
11. Screw in the 2 fixing screws and tighten them slightly.

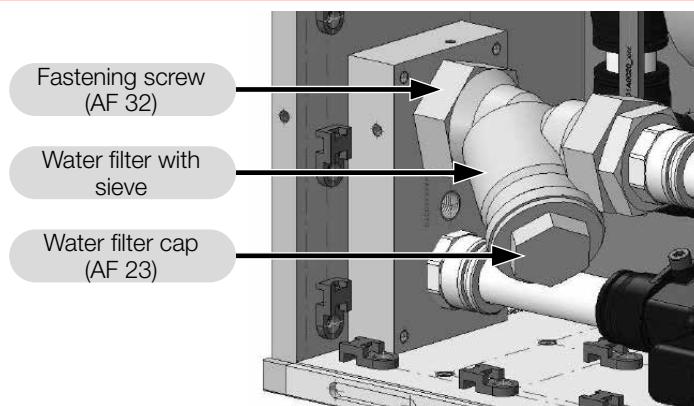

Fig. 11.2: Unscrew the cap of the water filter

12 Measures for the product disposal

As a B2B device, this PRIMES measuring device is subject to the European Waste Electrical and Electronic Equipment (WEEE) Directive and the corresponding national laws. The WEEE directive obliges the operating company to dispose of the device in an environmentally sound manner, not with household waste, but in a separate WEEE collection.

PRIMES gives the opportunity to return PRIMES measuring devices for free disposal within the scope of the Waste of Electrical and Electronic Equipment (WEEE Directive). This service does not include shipping costs. Send PRIMES measuring devices to be disposed of within the EU to our address:

PRIMES GmbH
Max-Planck-Str. 2
64319 Pfungstadt
Germany

If you are located outside the EU, please contact your local PRIMES distributor to discuss the disposal procedure for your PRIMES measuring device.

PRIMES is registered at the German „joint body“ for producers „Stiftung Elektro-Altgeräte Register“ (Stiftung EAR). Our number is: WEEE-reg.-no. DE65549202.

13 Declaration of conformity

Original EG Declaration of Conformity

The manufacturer: PRIMES GmbH, Max-Planck-Straße 2, 64319 Pfungstadt, Germany,
hereby declares that the device with the designation:

PowerMonitor (PM+)

Types: PM+ HP15

is in conformity with the following relevant EC Directives:

- EMC Directive EMC 2014/30/EU
- Low voltage Directive 2014/35/EU
- Directive 2011/65/EC on the restriction of the use of certain hazardous substances (RoHS) in electrical and electronic equipment

Authorized for the documentation:
PRIMES GmbH, Max-Planck-Straße 2, 64319 Pfungstadt, Germany

The manufacturer obligates himself to provide the national authority in charge with technical documents in response to a duly substantiated request within an adequate period of time.

Pfungstadt, January 12, 2022



Dr. Reinhard Kramer, CEO

UKCA Declaration of Conformity

The manufacturer: PRIMES GmbH, Max-Planck-Straße 2, 64319 Pfungstadt, Germany,
hereby declares that the device with the designation:

PowerMonitor (PM+)

Types: PM+ HP15

is in conformity with the following relevant UK Regulations:

- Electromagnetic Compatibility Regulations 2016
- Electrical Equipment (Safety) Regulations 2016
- The Restriction of the Use of Certain Hazardous Substances in Electrical and Electronic Equipment Regulations 2012

Authorized for the documentation:
PRIMES GmbH, Max-Planck-Straße 2, 64319 Pfungstadt, Germany

The manufacturer obligates himself to provide the national authority in charge with technical documents in response to a duly substantiated request within an adequate period of time.

Pfungstadt, January 12, 2022



Dr. Reinhard Kramer, CEO

14 Technical data

Measurement parameters		PM+ HP15
Power range		0,8 – 15 kW
Laser type		Continuous (cw) For pulsed lasers, please contact PRIMES.
Wavelength range		450 nm, 515 – 532 nm, 800 – 1 100 nm, 10 600 nm
Max. power density at wavelength	450 nm, 515 – 532 nm	10 kW/cm ²
	800 – 1 100 nm, 10 600 nm	15 kW/cm ²
Device parameters		
Entrance aperture		48 mm
Min./max. beam diameter ¹⁾		20/24 mm
Max. centered tolerance ¹⁾		± 3 mm
Min. divergence full angle (convergent) Max. divergence full angle (divergent) ¹⁾		– 50 mrad + 160 mrad
Max. angle of incidence perpendicular to entrance aperture ¹⁾		± 5°
Accuracy at wavelength	450 nm, 515 – 532 nm	± 2.5 %
	800 – 1 100 nm, 10 600 nm	± 2.0 %
Reproducibility		± 1 %
Time constant		20 s up to 99 % of final value
¹⁾ All specifications apply to the respective maximum values.		
Supply data		
Power supply, DC	PRIMES power supply	24 V ± 5 %, max. 0,5 A
	Power over Ethernet (Standard IEEE 802.3af (802.3at Type1), Power class 3)	24 V
	USB (Type USB-C, Version USB 2.0)	USB-C connection to PC: max. 5 V (DC) USB-C power supply (not included in delivery): max. 20 V (DC)
Cooling water	Hose diameter	16 mm
	Min. cooling water flow (interlock threshold)	6 l/min
	Max. cooling water flow	25 l/min
	Min. cooling water pressure	2 bar
	Max. cooling water pressure	6 bar
	Cooling water temperature Tin	Dew point temperature < Tin < 30 °C
Stability of the cooling water temperature	< 1.0 K per minute or 0.08 K per 5 seconds	
Communication		
Interfaces		Ethernet/PoE, USB-C/Interlock

Dimensions and Weights	
Dimensions (L x W x H) with connectors and shutter knob without device feet	375 x 180 x 190 mm
Weight (approx.)	12 kg
Environmental conditions	
Operating temperature range	15 – 40 °C
Storage temperature range	5 – 50 °C
Reference temperature	22 °C
Relative air humidity (non condensing)	10 – 80 %
PRIMES is committed to a continuous product improvement strategy, which can lead to specifications being optimised without any prior announcement.	

15 Dimensions

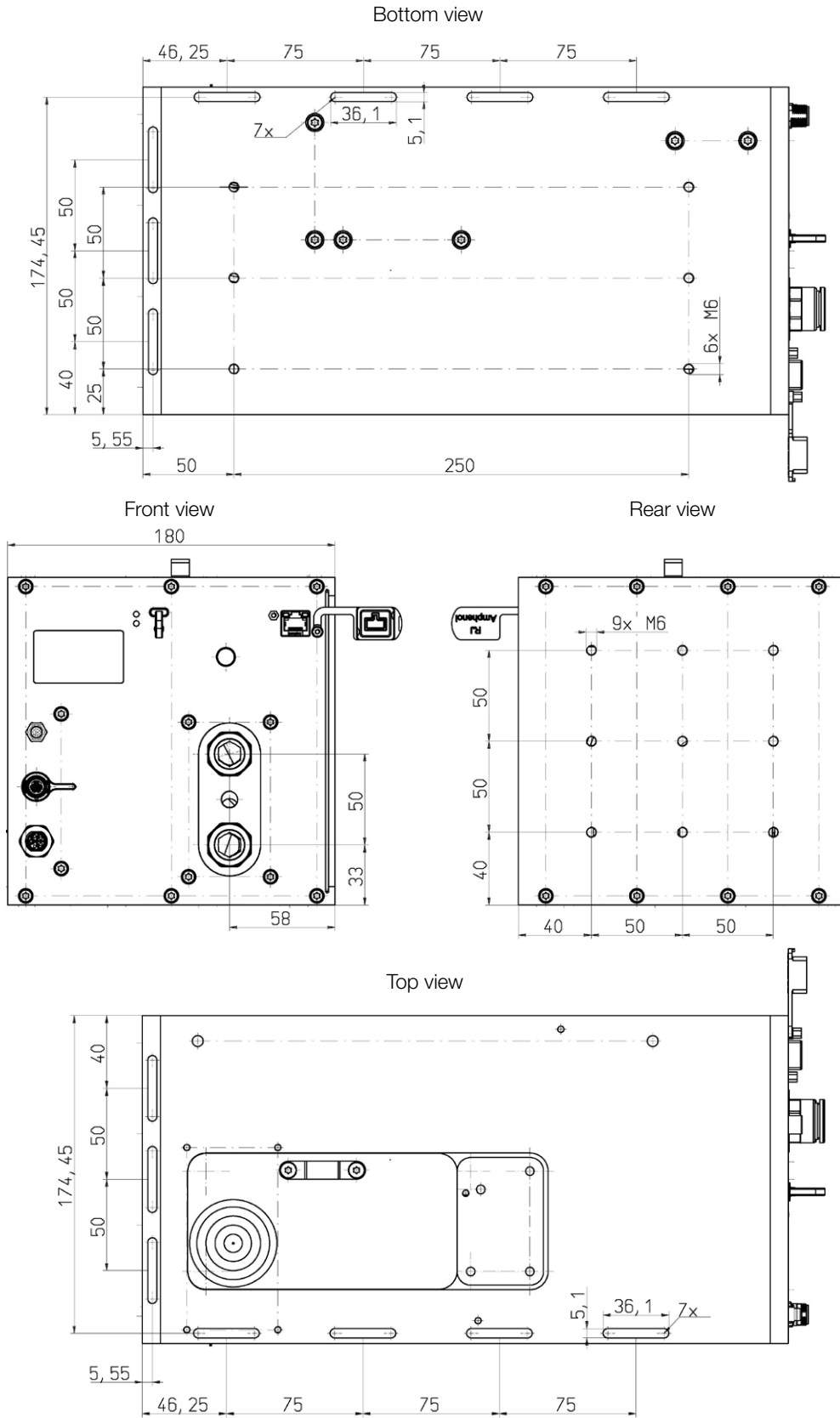

Dimensions in mm

16 Appendix

A Diagram of the max. laser power as a function of the beam diameter

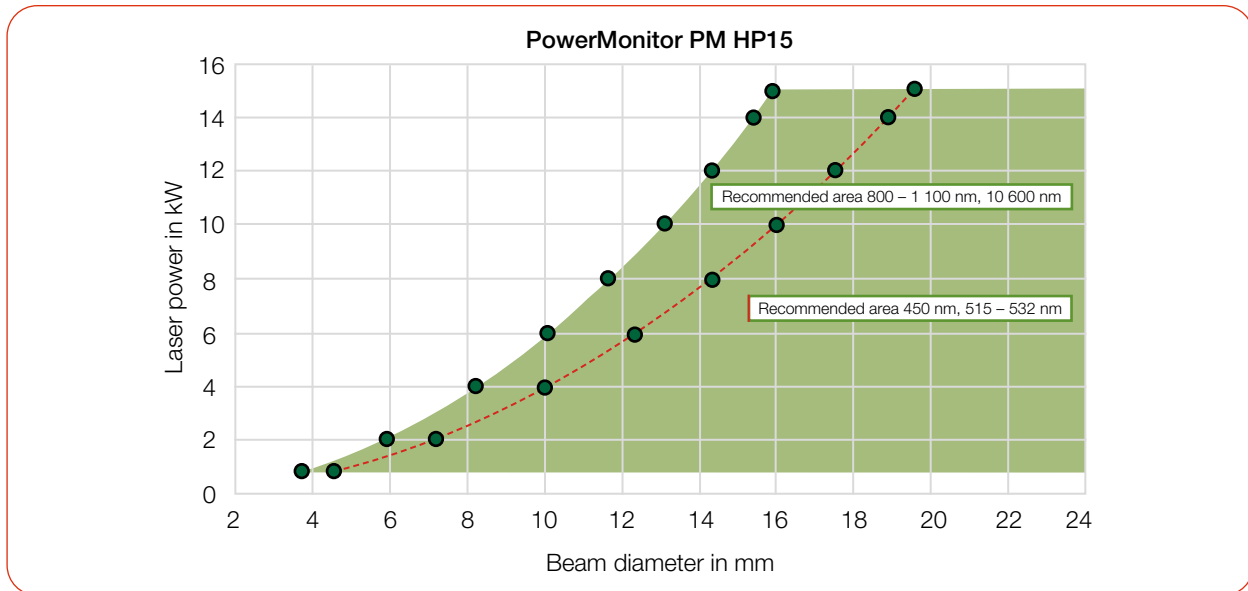

B GNU GPL license notice

The software of this product contains software code that is licensed subject to the GNU General Public License (GPL) Version 2 or later. The license terms of the GNU GPL Version 2 or later are available on the following websites:

- <https://www.gnu.org/licenses/old-licenses/gpl-2.0.en.html>
- <https://www.gnu.org/licenses/licenses.en.html>

C Parallel operation of the PM+ HP15 with a FocusMonitor FM+

C.1 Mount devices

Mount the FM+ to the PM+ using the adapter plate. The devices are aligned with each other by 2 dowel pins.

1. Disassemble the sliding knob on the shutter of the PM+.
2. Insert 2 dowel pins into the adapter plate.
3. Mount the adapter plate to the PM+ with 4 cylinder head screws.
4. Mount the angle plate to the shutter using 2 countersunk screws.
5. Mount the sliding knob to the angle plate using 2 countersunk screws.
6. Mount the FM+ to the adapter plate using 4 cylinder head screws.

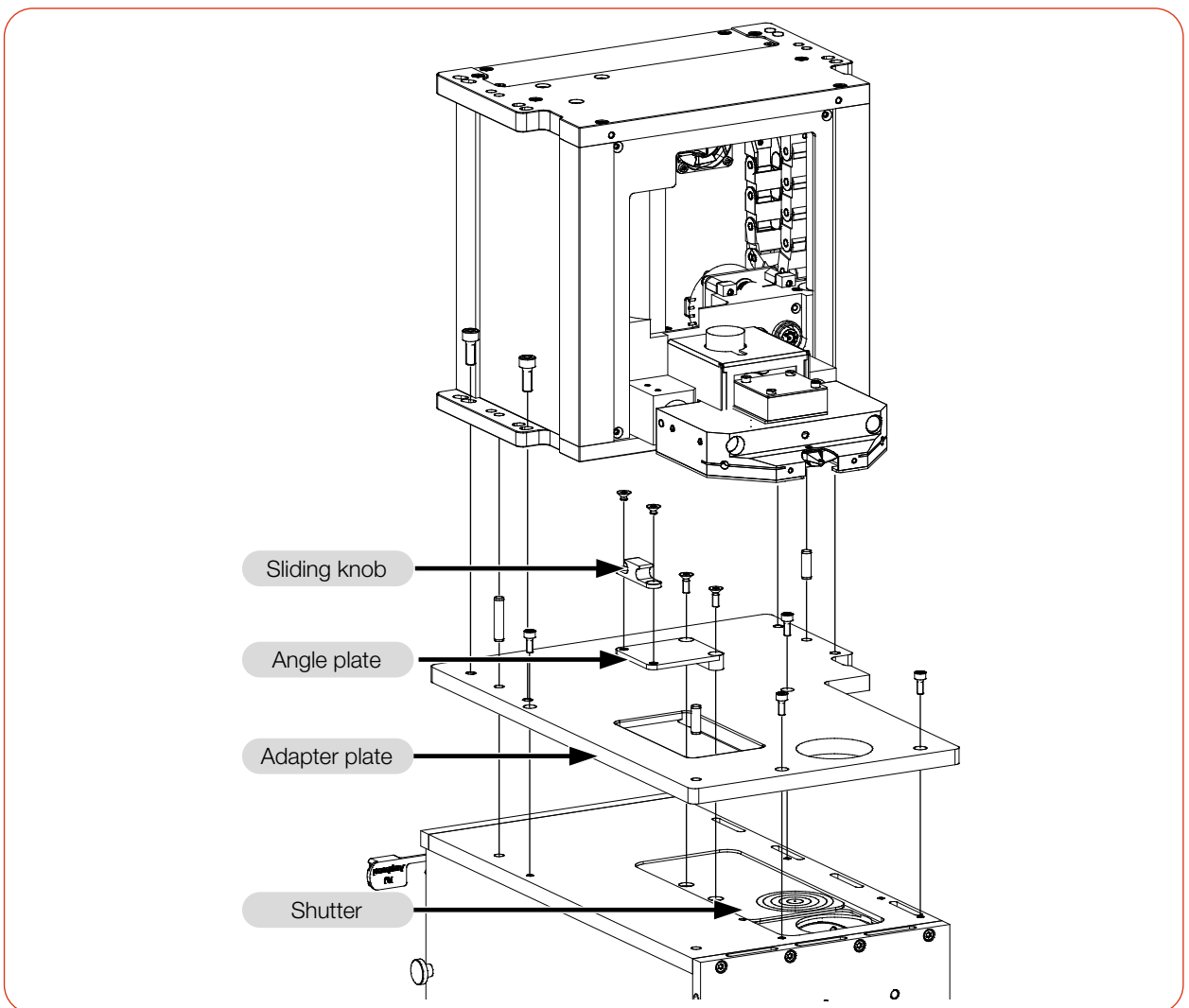

Fig. C.1: Mounting the FM+ on the PM+

C.2 Connect devices

1. Connect the FM+ to the PC via Ethernet.
2. Connect the PM+ to the PC via Ethernet/Power over Ethernet (PoE In) or via the USB-C interface to the PC.
3. Connect the PRIMES power supply to the FM+.

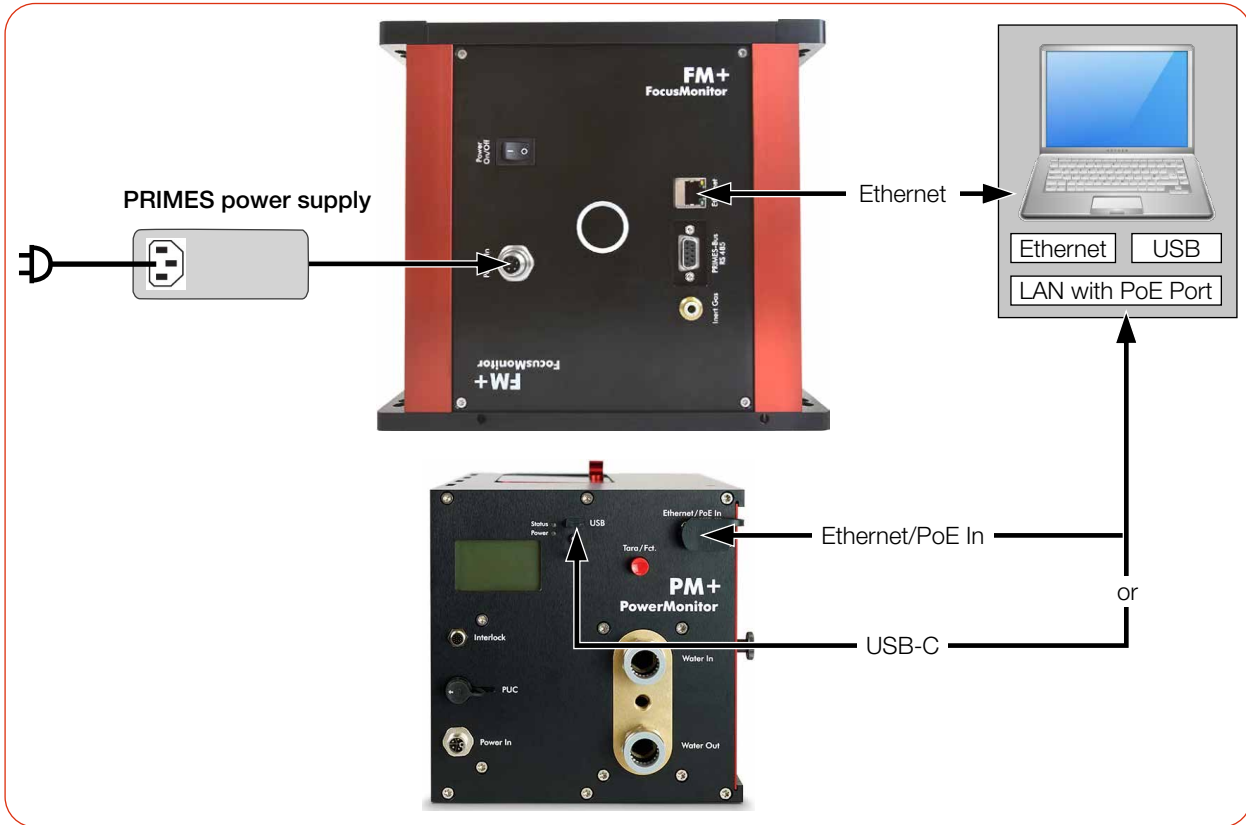

Fig. C.2: Connecting the FocusMonitor FM+ with the PowerMonitor PM+

D Parallel operation of the PM+ HP15 with a FocusTracker FT

D.1 Mount devices

Mount the FT with the adapter plate to the PM+.

1. Open the shutter with the slide knob.
2. Mount the adapter plate to the PM+ with 4 cylinder head screws.
3. Position the FT on the adapter plate so that the entrance apertures of the FT and the PM+ are aligned.
4. Place the 4 rectangular washers in the recesses for the mounting claws.
5. Screw the FT to the adapter plate with 4 cylinder head screws.

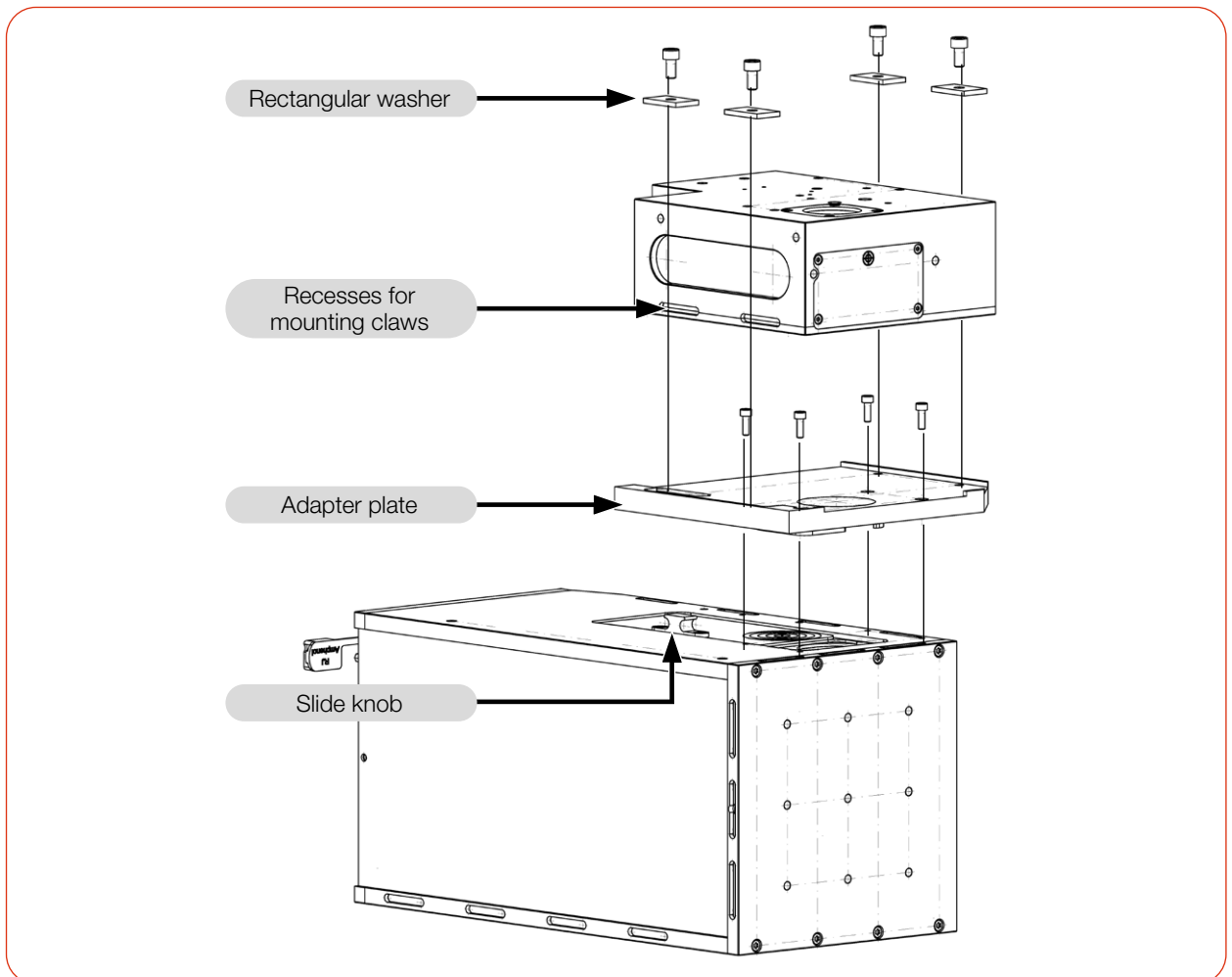

Fig. D.1: Mounting the FT on the PM+

D.2 Connect devices

1. Connect the FT to the PC via Ethernet (RJ 45)/Power over Ethernet to the PC.
2. Connect the PM+ to the PC via Power over Ethernet (PoE In) or via the USB-C interface to the PC.

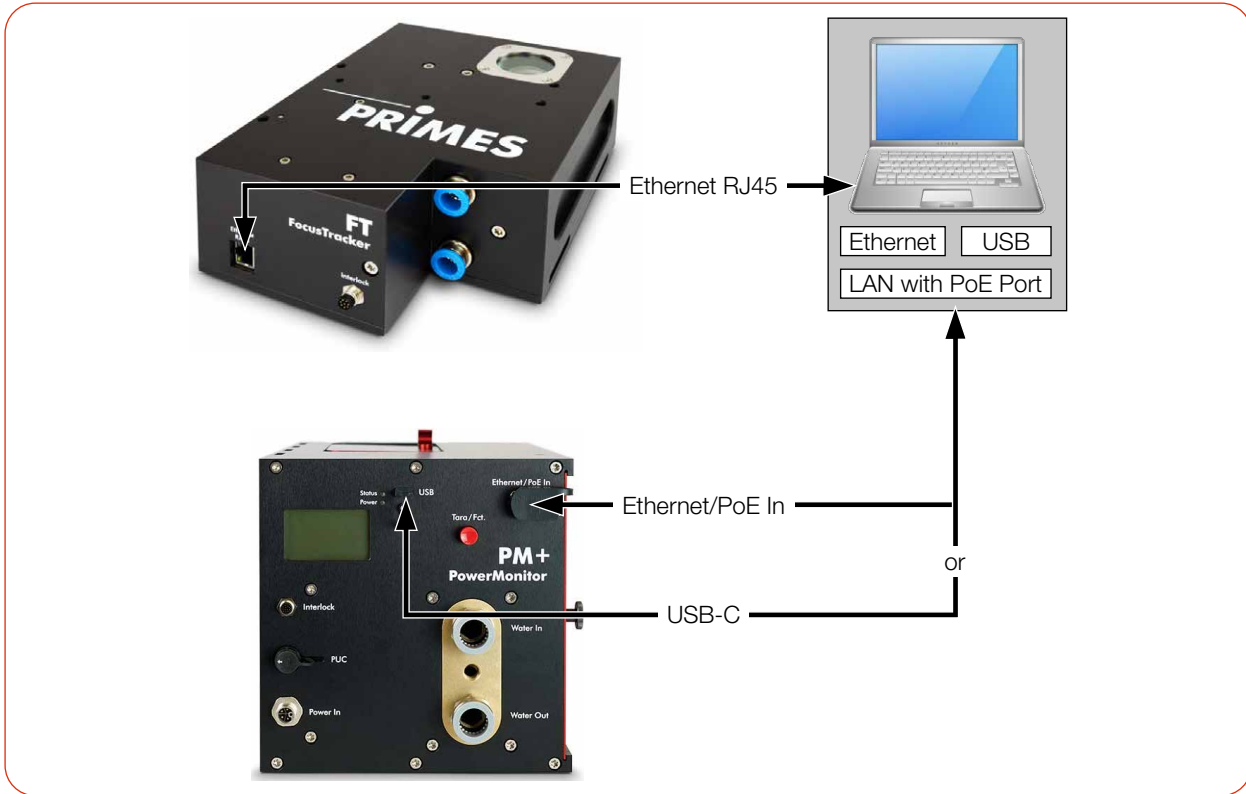

Fig. D.2: Connecting the FocusTracker FT with the PowerMonitor PM+